



FAX-410/500M

OWNER'S MANUAL

brother®

Your Brother Fax Reference Section

SECTION II

- **The control panel keys**

A description of the control panel is shown on page II-3-1.

SECTION III

- **Loading paper**

Paper loading is described on page III-5-1.

- **Connecting your fax to the telephone line.**

The method for connecting the machine to a telephone line is described on page III-6-1.

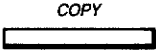

- **Making a copy**

Step	Symbol	Operation	Display
1		Set the document face down in the feeder.	FAX : ENTER FAX NO. COPY : PRESS COPY KEY
2		Press COPY.	COPYING P.01



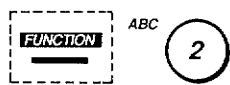

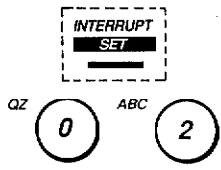

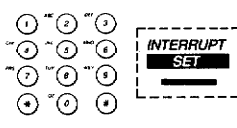
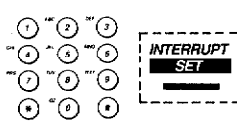
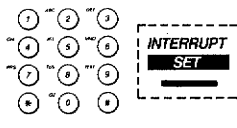
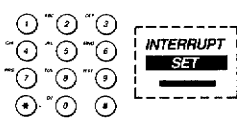
SECTION IV

- **Setting the date and time**

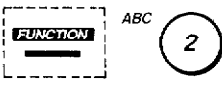
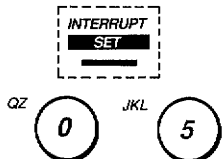

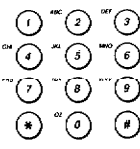
Step	Symbol	Operation	Display
1		Make sure there is no document in the feeder.	01/01/1991 00:00 FAX/COPY : SET DOC.
2		Press FUNCTION, then "2".	2.REGISTRATION PRESS SET KEY

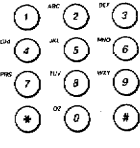
Step	Symbol	Operation	Display
3		Press SET, then "0" followed by "2".	<div style="border: 1px solid black; padding: 5px; text-align: center;"> 02.DATE-TIME PRESS SET KEY </div>
4		Press SET.	<div style="border: 1px solid black; padding: 5px; text-align: center;"> YEAR : <u>XX</u> INPUT / PRESS SET TO END </div>
5		Enter the last two digits of current year, then SET.	<div style="border: 1px solid black; padding: 5px; text-align: center;"> MONTH : <u>XX</u> INPUT / PRESS SET TO END </div>
6		Enter the current month as a 2-digit number, then SET.	<div style="border: 1px solid black; padding: 5px; text-align: center;"> DAY : <u>XX</u> INPUT / PRESS SET TO END </div>
7		Enter the day as a 2-digit number, then SET.	<div style="border: 1px solid black; padding: 5px; text-align: center;"> TIME : <u>XX</u>:<u>XX</u> INPUT / PRESS SET TO END </div>
8		Enter the time, then set.	

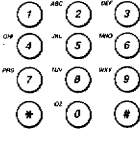
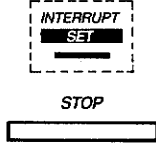

• Registering your name and number

Step	Symbol	Operation	Display
1		Press FUNCTION, then "2".	2.REGISTRATION PRESS SET KEY
2		Press SET, then "0" followed by "5".	05.STATION ID PRESS SET KEY
3		Press SET.	FAX: _ INPUT / PRESS SET TO END
4		Use the number keys to enter your fax number.	FAX: 0528115981_ INPUT / PRESS SET TO END
5		Press SET.	TEL: _ INPUT / PRESS SET TO END
6		Use the number keys to enter your telephone number.	TEL: 0528242554_ INPUT / PRESS SET TO END
7		Press SET.	NAME: _ INPUT / PRESS SET TO END
8		Use the number keys to enter the name you wish to appear on the faxes.	NAME: BROTHER_ INPUT / PRESS SET TO END
9		Press SET. Then press STOP key.	06/01/1991 12:00 FAX/COPY : SET DOC.

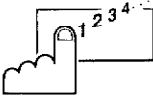
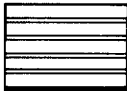



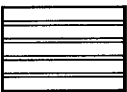







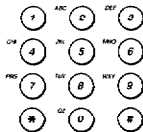

• Sending a fax (manual transmission)

Step	Symbol	Operation	Display
1		Set the document face down in the feeder.	FAX : ENTER FAX NO. COPY : PRESS COPY KEY
2	HOOK  or 	Press HOOK or pick up the handset.	FAX ENTER FAX NO.
3		Dial the number of the destination.	03875497 ENTER FAX NO.
4	START 	When you hear the fax tone, press the START key. (Hang up after this if you are using the handset.)	03875497 SENDING

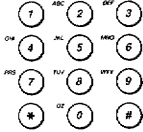

• Manual reception of faxes

Step	Symbol	Operation	Display
1		Answer the phone as usual when it rings.	TELEPHONE/FAX
2	START 	Press START after you hear a fax tone. Reception will begin.	RECEIVING
3		Hang up the handset.	RECEIVING

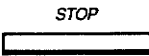



• Registering one-touch numbers

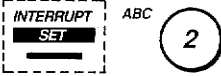

Step	Symbol	Operation	Display
1	 	Press FUNCTION, then 1.	1.ONE-TOUCH / SPEED DIAL PRESS SET KEY
2	 	Press SET, then 1.	1.ONE-TOUCH DIAL PRESS SET KEY
3		Press SET.	ONE-TOUCH DIAL SELECT ONE-TOUCH KEY
4		Select the one-touch number to be registered. (e.g. press 5.)	*05:_ INPUT / PRESS SET TO END
5		Use the number keys to enter the telephone or fax number.	*05:3087831735_ INPUT / PRESS SET TO END
6		Press SET.	NAME:_ INPUT / PRESS SET TO END
7		Use the number keys to enter the name of the destination.	*05:BROTHER MIZUHO_ INPUT / PRESS SET TO END
8	  ,  	Press SET, then "1", "2" or "3".	CURRENT : FAX 1.FAX 2.TEL 3.OFF
9		Press SET.	ONE-TOUCH DIAL SELECT ONE-TOUCH KEY
10		Press STOP to end registration.	06/01/1991 12:00 FAX/COPY : SET DOC.

• Sending a one-touch fax

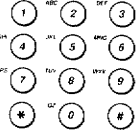
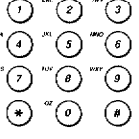

Step	Symbol	Operation	Display
1		Set the document face down in the feeder.	FAX : ENTER FAX NO. COPY : PRESS COPY KEY
2		Press the one-touch number key (e.g. 5).	BROTHER MIZUHO PRESS START KEY
3		Press START.	BROTHER MIZUHO SENDING

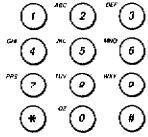
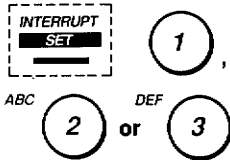
• Registering speed dial numbers

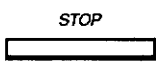

Step	Symbol	Operation	Display
1		Press FUNCTION, then "1".	1.ONE-TOUCH / SPEED DIAL PRESS SET KEY
2		Press SET, then "2".	2.SPEED DIAL PRESS SET KEY
3		Press SET .	SPEED DIAL SELECT NO. #_
4		Enter the two digit speed dial number to be registered (e.g. 10).	SPEED DIAL SELECT NO. #10
5		Use the number keys to enter the telephone or fax number.	#10:3087831735_ INPUT / PRESS SET TO END
6		Press SET.	NAME:_ INPUT / PRESS SET TO END

Step	Symbol	Operation	Display
7		Use the number keys to enter the name of the destination.	<div style="border: 1px solid black; padding: 5px;"> NAME:U.K. OFFICE_ INPUT / PRESS SET TO END </div>
8		Press SET, then "1", "2" or "3".	<div style="border: 1px solid black; padding: 5px;"> CURRENT : FAX 1.FAX 2.TEL 3.OFF </div>
9		Press SET.	<div style="border: 1px solid black; padding: 5px;"> SPEED DIAL SELECT NO. #_ </div>
10		Press STOP to end registration.	<div style="border: 1px solid black; padding: 5px;"> 06/01/1991 12:00 FAX/COPY : SET DOC. </div>

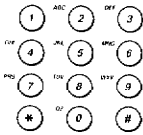
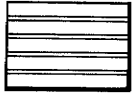

• Sending speed dial faxes

Step	Symbol	Operation	Display
1		Set the document face down in the feeder.	FAX : ENTER FAX NO. COPY : PRESS COPY KEY
2	SPD.DIAL 	Press the SPD.DIAL key.	# ENTER SPEED NO.
3		Use the number keys to enter the two digit speed dial combination (e.g. 10).	U.K. OFFICE PRESS START KEY
4	START 	Press START.	U.K. OFFICE SENDING

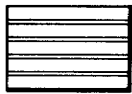
• Sending telephone index faxes

Step	Symbol	Operation	Display
1		Set the document face down in the feeder.	FAX : ENTER FAX NO. COPY : PRESS COPY KEY
2	TEL-INDEX 	Press the TEL.INDEX key.	TEL.INDEX ENTER CHARACTER
3		Press the appropriate letter key and (←/→) cursor keys to call up the name you want.	NINJ OFFICE PRESS ←→OR START KEY
4	START 	Press START.	NJ OFFICE SENDING



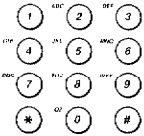
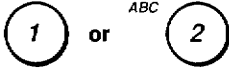
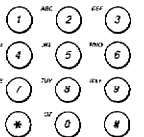
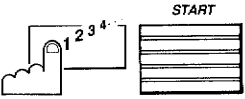

• Sending a fax with a super COVERPAGE

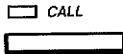
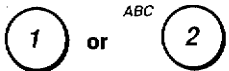
Step	Symbol	Operation	Display
1		Set the document face down in the feeder.	FAX : ENTER FAX NO. COPY : PRESS COPY KEY
2		Press COVERPAGE.	SELECT COMMENT (1-6) 2.PLEASE CALL
3		Press a number key (1-6) to select a comment (e.g. 2).	COVERPAGE 2.PLEASE CALL
4		Select "1" to show the total number of pages, or "2" to off.	TOTAL NO. OF PAGES 1.ON 2.OFF
5		Use the number keys to enter the total number of pages to be sent.	TOTAL PAGES : 12 ENTER TOTAL NO. OF PAGES
6		Enter the fax number. Press START.	308 783 1735 SENDING COVERPAGE



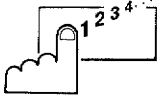

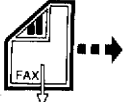
• Sending a fax with call reservation

Step	Symbol	Operation	Display
1		Set the document face down in the feeder.	FAX : ENTER FAX NO. COPY : PRESS COPY KEY
2		Press CALL.	CALL BACK MSG. 1.ON 2.OFF
3		Press "1" or "2".	ENTER FAX NO.

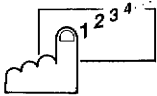

Your Brother Fax Reference Section

Step	Symbol	Operation	Display
4		Enter the fax number of the destination.	NJ OFFICE PRESS START KEY
5		Press START.	NJ OFFICE SENDING
6		After the transmission, the unit at the other end will ring.	CALLING
7		If the other party answers, your machine will ring. Pick up the handset and talk.	CALL PICKUP

• Standard polling

Step	Symbol	Operation	Display
1		Make sure there is no document in the feeder.	06/01/1991 14:00 FAX/COPY : SET DOC.
2		Press POLLING.	SELECT NO. 1. STANDARD 2. SECURE
3		Press 1.	POLL ENTER FAX NO.
4		Enter the fax number of the machine to be polled.	308 783 1735 PRESS START KEY
5		Press START.	308 783 1735 RECEIVING

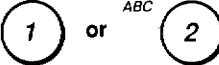
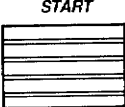

• **Setting a document to be polled**

Step	Symbol	Operation	Display
1		Set the document face down in the feeder.	FAX : ENTER FAX NO. COPY : PRESS COPY KEY
2		Press POLLING.	SELECT NO. 1.STANDARD 2.SECURE
3		Press "1" or "2".	POLL PRESS START KEY -OR- POLL ENTER FAX NO.
4		Press START.	06/01/1991 13:00 WAITING -OR- POLL WAITING

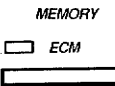
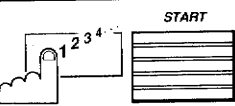

• **Sending a fax from memory (only for FAX-500M)**

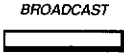
Step	Symbol	Operation	Display
1		Set the document face down in the feeder.	FAX : ENTER FAX NO. COPY : PRESS COPY KEY
2		Press MEMORY/ECM.	ENTER FAX NO. 100%
3		Enter the destination fax number, then press START.	MEMORY 98%





• Sending a broadcast fax (only for the FAX-500M)

Step	Symbol	Operation	Display
1		Set the document face down in the feeder.	FAX : ENTER FAX NO. COPY : PRESS COPY KEY
2		Press BROADCAST.	BROADCAST ENTER FAX NO. 100%
3		Use a one-touch, speed, or group key to enter the number of the destination machines.	*01#10G03 DUTCH OFFICES
4		Press START.	NJ OFFICE SENDING

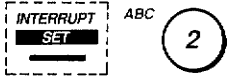

• Printing out confidential information (only for FAX-500M)

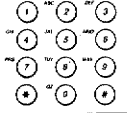
Step	Symbol	Operation	Display
1		Make sure there is no document in the feeder.	06/01/1991 12:35 FAX/COPY : SET DOC.
2		Press MAIL.	CONF. MESSAGE INFO. PRESS START KEY
3		Press START.	CONF. MESSAGE INFO. PRINTING

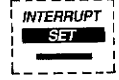

• Printing out confidential message (only for FAX-500M)

Step	Symbol	Operation	Display
1		Press FUNCTION, then "7".	7.CONFIDENTIAL MAIL BOX PRESS SET KEY
2		Press SET, then "2".	2.CONF. PRINT OUT PRESS SET KEY
3		Press SET.	RETRIEVAL ID : XXXX ENTER CODE NO.
4		Enter the retrieval ID code.	RETRIEVAL ID : 6349 PRESS SET KEY
5		Press SET.	CONF. MESSAGE PRINTING

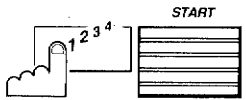
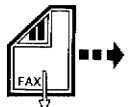

• Interrupting a transmission

Step	Symbol	Operation	Display
1		Press INTERRUPT.	INTERRUPT TO RESET PRESS INTERRUPT - OR - INTERRUPT REMOVE DOCUMENT
2		Remove the document.	INTERRUPT SET DOCUMENT(S)
3		Set the document, you need to send, face down in the feeder.	INTERRUPT TO RESET PRESS INTERRUPT - OR - INTERRUPT ENTER FAX NO.

Your Brother Fax Reference Section

Step	Symbol	Operation	Display
4		Enter a fax number, then START.	NJ OFFICE SENDING
5		The document has been sent.	INTERRUPT SET DOCUMENT(S)
6		Replace the original document.	INTERRUPT TO RESET PRESS INTERRUPT -OR- INTERRUPT ENTER FAX NO.
7		Press INTERRUPT.	06/01/1991 12:00 FAX/COPY : SET DOC.

• Canceling a transmission

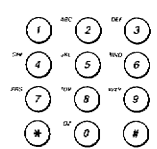
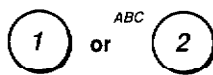
Step	Symbol	Operation	Display
1		Press FUNCTION, then "9".	9.CANCEL TRANSMISSION PRESS SET KEY
2		Press SET.	SELECT NO. 1.HEAD OFFICE 21:00 -OR- SELECT NO. 2.341 1411 REDIAL
3		Select the number of any operation, you wish to cancel.	HEAD OFFICE 21:00 CANCEL ? 1.YES 2.NO
4		Enter "1" or "2".	

Contents

I. Preliminary information	I-1
GLOSSARY	I-1
SYMBOLS USED IN THIS MANUAL	I-3
IMPORTANT SAFETY INSTRUCTIONS	I-4
STANDARD TELEPHONE AND FCC NOTICES	I-6
II. Introduction	II-1-1
1. INTRODUCTION	II-1-1
2. FEATURES	II-2-1
3. THE CONTROL PANEL KEYS	II-3-1
4. FUNCTIONS	II-4-1
III. Setting up	III-1-1
1. SELECTING A LOCATION FOR YOUR FAX MACHINE	III-1-1
2. UNPACKING THE MACHINE	III-2-1
3. ASSEMBLING THE HANDSET	III-3-1
4. INSTALLING THE WIRE EXTENSIONS	III-4-1
5. LOADING PAPER	III-5-1
6. CONNECTING YOUR FAX TO THE POWER OUTLET	III-6-1
7. CONNECTING TO A TELEPHONE LINE	III-7-1
Jacks	III-7-1
Multi Line Connections (PBXs)	III-7-1
Connecting to a private branch exchange	III-7-2
8. MAKING A TRIAL COPY	III-8-1
9. ADDITIONAL SET-UP OPTIONS	III-9-1
Connecting to an external telephone	III-9-1
Installing the one-touch dial label	III-9-1
IV. Basic use	IV-1-1
1. CONFIGURING THE MACHINE	IV-1-1
Setting the date and time	IV-1-1
Registering your name and number	IV-1-2
Entering information using the keys	IV-1-4
Selecting tone or pulse dialing	IV-1-6
Setting the auto answer switch	IV-1-7
FAX/TEL switch	IV-1-7
Setting F/T ringing period	IV-1-9
Setting the ring delay	IV-1-10
Turning auto redial on and off	IV-1-10
Turning the beeper on and off	IV-1-11
Turning the transmission verification report on and off	IV-1-12
2. SENDING A FAX	IV-2-1
Automatic transmission	IV-2-1
Manual transmission	IV-2-2
Loading multiple pages for transmitting or copying	IV-2-3

Current Setting for sending a fax	IV-2-3
Redialing	IV-2-5
3. RECEIVING A FAX	IV-3-1
Automatic reception	IV-3-1
Manual reception	IV-3-1
Reception with FAX/TEL switching	IV-3-1
Reception by Enhanced Remote Activation	IV-3-2
Remote activation	IV-3-2
Reception into memory (only for FAX-500M)	IV-3-2
Registering F/T & Remote ID	IV-3-3
4. USING ONE-TOUCH NUMBERS	IV-4-1
Registering one-touch numbers	IV-4-1
Registering one-touch numbers as a group key (only for FAX-500M)	IV-4-3
Sending one-touch faxes	IV-4-4
Printing a list of one-touch numbers	IV-4-4
Changing or Erasing one-touch names and numbers	IV-4-6
5. USING SPEED DIAL NUMBERS	IV-5-1
Registering speed dial numbers	IV-5-1
Sending speed dial faxes	IV-5-2
Printing a list of speed dial numbers	IV-5-2
Changing or Erasing speed dial names and numbers	IV-5-3
6. CHAIN DIALING	IV-6-1
Setting chain dialing	IV-6-1
7. USING THE TELEPHONE INDEX	IV-7-1
Looking up a number	IV-7-1
Sending a fax	IV-7-1
Printing out the telephone index	IV-7-2
8. USING THE UNIT AS A TELEPHONE	IV-8-1
Manual dialing	IV-8-1
One-touch dialing	IV-8-1
Speed dialing	IV-8-1
Using the telephone index	IV-8-1
Using keys with the telephone	IV-8-2
Using an external telephone	IV-8-2
Using an external telephone answering device	IV-8-2
V. Advanced use	V-1-1
1. RESOLUTION	V-1-1
Single resolution transmission	V-1-1
Multiple resolution transmission	V-1-2
The resolution of in-coming documents	V-1-3
Copier resolution	V-1-3

2. SETTING THE CONTRAST	V-2-1
3. SMOOTHING (ENHANCED IMAGE RESOLUTION)	V-3-1
4. USING THE SUPER COVERPAGE FACILITY	V-4-1
Sending a fax with a super COVERPAGE	V-4-1
Printing out a super COVERPAGE	V-4-2
Entering a comment	V-4-3
5. CALL RESERVATION AND THE CALL BACK MESSAGE	V-5-1
Sending a fax with Call Reservation	V-5-1
Printing out a Call Back Message	V-5-2
6. TIMER TRANSMISSION (DELAYED TRANSMISSION)	V-6-1
Sending a fax with Timer	V-6-1
Initial timer	V-6-3
7. THE PASSWORD	V-7-1
Sending a FAX with password	V-7-1
Setting the fax receiving password	V-7-2
Turning password protection on and off	V-7-3
8. POLLING	V-8-1
What is polling?	V-8-1
Standard polling	V-8-2
Secure polling	V-8-2
Timer (Delayed) polling	V-8-3
Turn-around polling	V-8-5
Sequential polling (only for FAX-500M)	V-8-6
Setting a document to be polled	V-8-7
9. SENDING FAXES FROM MEMORY (only for FAX-500M)	V-9-1
Sending a fax from memory	V-9-1
Printing out a "Memory used list"	V-9-2
10. SENDING FAXES WITH THE ECM FEATURE (only for FAX-500M)	V-10-1
11. BROADCASTING (only for FAX-500M)	V-11-1
Sending a broadcast fax	V-11-1
12. RELAY BROADCASTING (only for FAX-500M)	V-12-1
Sending a relay broadcast request	V-12-1
Using your machine as the relay unit	V-12-2
Registration of relay ID	V-12-2
13. CONFIDENTIAL MAILBOXES (only for FAX-500M)	V-13-1
Registering a confidential mailbox	V-13-1
Changing the mail box ID	V-13-3
Printing out confidential information report	V-13-3
Printing out a confidential message	V-13-4
Transmitting to a mail box	V-13-5
Retrieving confidential messages	V-13-6
14. VARIOUS TYPES OF TRANSMISSIONS	V-14-1

15. INTERRUPTING A TRANSMISSION	V-15-1
16. CANCELLING A TRANSMISSION	V-16-1
17. OPTIONAL KITS	V-17-1
18. PRINTING OUT REPORTS AND LISTS	V-18-1
All-dial list	V-18-1
Configuration list	V-18-2
Power failure report (only for FAX-500M)	V-18-4
VI. Troubleshooting	VI-1
Receiving	VI-1
Sending	VI-2
Telephone	VI-3
Copying	VI-3
Others	VI-4
Error messages	VI-5
VII. Cleaning	VII-1
Cleaning the printing area	VII-2
Cleaning the scanner	VII-3
VIII. Specifications	VIII-1

I. Preliminary information

GLOSSARY

This glossary is a reference to help you understand terms used in this manual which may be unfamiliar.

ADF	Automatic Document Feeder - this allows the insertion of up to 20 originals for transmission or copying.
Broadcasting	This function permits the transmission of a fax to several different stations in a single operation. (only for model FAX-500M)
Chain dialing	An option which allows you to use two one-touch or speed dial numbers for an automatic transmission. (for example, when you are using telephone credit card.)
Confidential mailbox	This feature is used for sending and receiving documents that should be seen only by those who know the retrieval ID number. The FAX-500M (only) has three different mailboxes.
Convenience copier	A copier used to make occasional, temporary reproductions of documents.
ECM	The Error Correction Mode, which is a means of checking the integrity of a fax transmission. (only for FAX-500M)
F/T ringing time	This is the time (10, 20, or 30 seconds) set for extra ringing of the fax machine's telephone when receiving manual transmissions and/or telephone calls for the purpose of conversations.
Fax password	A security code that permits transmission to the fax units using the same code.
Fax receiving password	This password is used to prevent the reception of unwanted fax transmissions.
Fine resolution	Fax transmission mode used for detailed images. (203 x 196 lines/inch)
Gray scale	Shades of gray (16 levels for the unit) used to provide faithful reproduction of photographic images.
One-touch dialing	A feature which lets you dial a number by pressing just one key.
PBX	Private Branch Exchange, a computerized telephone switching system (usually found in large organizations) which accepts calls from the outside and transfers them to various extensions inside the organization. It is also used to route calls from the inside to destinations outside the organization.

GLOSSARY

Photo resolution

A mode used by the fax machine to transmit highly detailed camera images. (203 x 196 lines/inch).

Polling







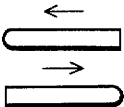
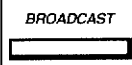

A feature used by fax machines to request documents from other fax machines. The unit has the capacity to poll (send requests for document transmission) and to be polled by (receive requests for document transmission) other machines.

**Timer transmission
(Delayed transmission)**

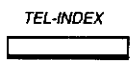
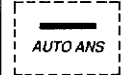
A feature which permits a document to be sent automatically to its destination at a time when the sender is not in the office and/or wants to take advantage of less expensive telephone rates.

SYMBOLS USED IN THIS MANUAL

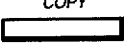
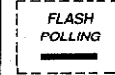
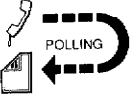
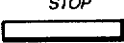
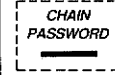
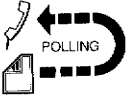
The symbols used in this manual are intended to make it easier for you to see the steps involved in a particular unit operation.

 : Handset up	 : Cursor keys	 : Broadcast key (only for FAX-500M)
 Set the document : face down in feeder	 : TEL-INDEX key	 : Manual/Auto answer key
 Make sure there is : no other document in feeder	 : Shift key (only for FAX-500M)	 : Timer key
 : A fax is sent	 : Copy key	 : Flash/Polling key
 : A machine is polling	 : Stop key	 : Chain/Password key
 : A machine is being polled	 : Start key	

IMPORTANT SAFETY INSTRUCTIONS

1. Read all of these instructions.
2. Save them for later reference.
3. Follow all warnings and instructions marked on the product.
4. Unplug this product from the wall outlet before cleaning. Do not use liquid or aerosol cleaners. Use a damp cloth for cleaning.
5. Do not use this product near water.
6. Do not place this product on an unstable cart, stand, or table. The product may fall, causing serious damage to the product.
7. Slots and openings in the cabinet and the back or bottom are provided for ventilation; to ensure reliable operation of the product and to protect it from overheating, these openings must not be blocked or covered. The openings should never be blocked by placing the product on a bed, sofa, rug, or other similar surface. This product should never be placed near or over a radiator or heat register. This product should not be placed in a built-in installation unless proper ventilation is provided.
8. This products should be operated from the type of power source indicated on the marking label. If you are not sure of the type of power available, consult your dealer or local power company.
9. This product is equipped with a 3-wire grounding type plug, a plug having a third (grounding) pin. This plug will only fit into a grounding-type power outlet. This is a safety feature. If you are unable to insert the plug into the outlet, contact your electrician to replace your obsolete outlet. Do not defeat the purpose of the grounding-type plug.
10. Do not allow anything to rest on the power cord. Do not locate this product where persons will walk on the cord.
11. If an extension cord is used with this product, make sure that the total of the ampere ratings on the products plugged into the extension cord do not exceed the extension cord ampere rating. Also, make sure that the total of all products plugged into the wall outlet does not exceed 15 amperes (U.S.A. only).
12. Never push objects of any kind into this product through cabinet slots as they may touch dangerous voltage points or short out parts that could result in a risk of fire or electric shock. Never spill liquid of any kind on the product.
13. Do not attempt to service this product yourself, as opening or removing covers may expose you to dangerous voltage points or other risks. Refer all servicing to service personnel.

14. Unplug this product from the wall outlet and refer servicing to qualified service personnel under the following conditions:
- A. When the power cord or plug is damaged or frayed.
 - B. If liquid has been spilled into the product.
 - C. If the product has been exposed to rain or water.
 - D. If the product does not operate normally when the operating instructions are followed. Adjust only those controls that are covered by the operating instructions since improper adjustment of other controls may result in damage and will often require extensive work by a qualified technician to restore the product to normal operation.
 - E. If the product has been dropped or the cabinet has been damaged.
 - F. If the product exhibits a distinct change in performance, indicating a need for service.

STANDARD TELEPHONE AND FCC NOTICES

These notices are in effect on models sold and used in America.

This equipment is hearing-aid compatible.

When programming emergency numbers and/or making test calls to emergency numbers:

- Remain on the line and briefly explain to the dispatcher the reason for the call before hanging up.
- Perform such activities in the off-peak hours, such as early morning or late evening.

This equipment complies with Part 68 of the FCC Rules. On the rear panel of this equipment is a label that contains, among other information, the FCC Registration Number and Ringer Equivalence Number (REN) for this equipment. You must, upon request, provide this information to your telephone company.

Ask your telephone company or installer to install the jack suitable for your device if such is not available.

The REN is useful to determine the quantity of devices you may connect to your telephone line and still have those devices ring when your telephone number is called. In most, but not all areas, the sum of the RENs of all devices connected to one line should not exceed five (5). To be certain of the number of devices you may connect to your line, as determined by the REN, you should contact your local telephone company to determine the maximum REN for your calling area.

If your telephone equipment causes harm to the telephone network, the telephone company may discontinue your service temporarily. If possible, they will notify you in advance. But if advanced notice is not practical, you will be notified as soon as possible. You will be informed of your right to file a complaint with the FCC.

Your telephone company may make changes in its facilities, equipment, operations or procedures that could affect the proper functioning of your equipment. If they do, you will be notified in advance to give you an opportunity to maintain uninterrupted telephone service.

If you experience trouble with this telephone equipment, please contact the manufacturer's authorized service agency for information on obtaining service or repair. The telephone company may ask that you disconnect this equipment from the network until the problem has been corrected or until you are sure that the equipment is not malfunctioning.

Warning

For protection against the risk of electrical shock, always disconnect all cables from the wall outlet before servicing, modifying or installing the equipment.

This equipment may not be used on coin service provided by the telephone company nor connected to party lines.

This equipment has been tested and found to comply with the limits for a Class B digital device, pursuant to Part 15 of the FCC Rules. These limits are designed to provide reasonable protection against harmful interference in a residential installation. This equipment generates, uses, and can radiate radio frequency energy and, if not installed and used in accordance with the instructions, may cause harmful interference to radio communications. However, there is no guarantee that interference will not occur in a particular installation. If this equipment does cause harmful interference to radio or television reception, which can be determined by turning the equipment off and on, the user is encouraged to try to correct the interference by one or more of the following measures:

- Re-orient or relocate the receiving antenna.
- Increase the separation between the equipment and receiver.
- Connect the equipment into an outlet on a circuit different from that to which the receiver is connected.
- Consult the dealer or an experienced radio/TV technician for help.

Brother cannot accept any financial or other responsibilities that may be the result of your use of this information, including direct, indirect, special or consequential damages. There are no warranties extended or granted by this document.

The serial number may be found on the label affixed to the back of the unit. For your convenience, note the number below and retain this owner's manual to serve as a permanent record of your purchase, in the event of a theft or fire, or for future reference.

MODEL NO. FAX-410/500M SERIAL NO. _____

NAME OF DEALER _____

DATE OF PURCHASE _____

II. Introduction

1. INTRODUCTION

This is a modern desktop facsimile unit which can be used for sending and receiving faxes via the public telephone lines. In addition to standard transmission and reception, the unit has a range of functions which facilitate fax transmission and reception and will help keep your business operating efficiently.

This owner's manual has been included with your fax machine to help you make use of the functions provided.

2. FEATURES

Your fax machine has many useful features. These include:

- High speed transmission (9600 b.p.s).
- A 48-character LCD screen and helpful prompts. When you have to make a selection, all the available choices are automatically briefly displayed on the screen scrolling.
- Many dedicated function keys.
- Non-curl mechanism, which stretches out the curls of recording roll paper (effective 1 inch/3 cm core).
- Auto Document Feeder (ADF), which allows you leave unattended faxes for transmission. You can set up to 20 documents in the ADF.
- A Tel-Index function, which is a built-in name and number directory list facility.
- The polling function, with which you can request transmission of faxes from other stations. Polling can also be protected by a security code.
- Various reports to confirm that your document has successfully been sent to its destination. (For example, transmission verification reports, etc....)
- A delayed transmission feature which lets you send faxes when telephone rates are low.
- A password security function to prevent "junk" faxes, and to avoid the sending of faxes to the wrong party.
- Four resolution levels (standard/fine/super fine/photo) to provide superior quality document transmission.
- Character smoothing on in-coming fax transmissions.
- A super COVERPAGE feature enabling you to send information describing your fax transmission to the receiving party.
- The facility for interrupting and then resuming an operation.
- Copier capability.
- FAX/TEL switch, which allows you to use one telephone line to both Fax and Telephone.

– only for FAX-500M –

- Three confidential mailboxes for storing confidential messages.
- Memory capacity for storing up to approximately 14 pages. (Brother Standard Chart).
- Reception into memory, which allows you to receive fax messages even if your machine runs out of paper.
- A broadcasting function, which lets you send one fax to several different fax units in one operation.
- You can increase your machine's memory size up to 768KB (optional).

3. THE CONTROL PANEL KEYS

FAX-500M

II. Introduction

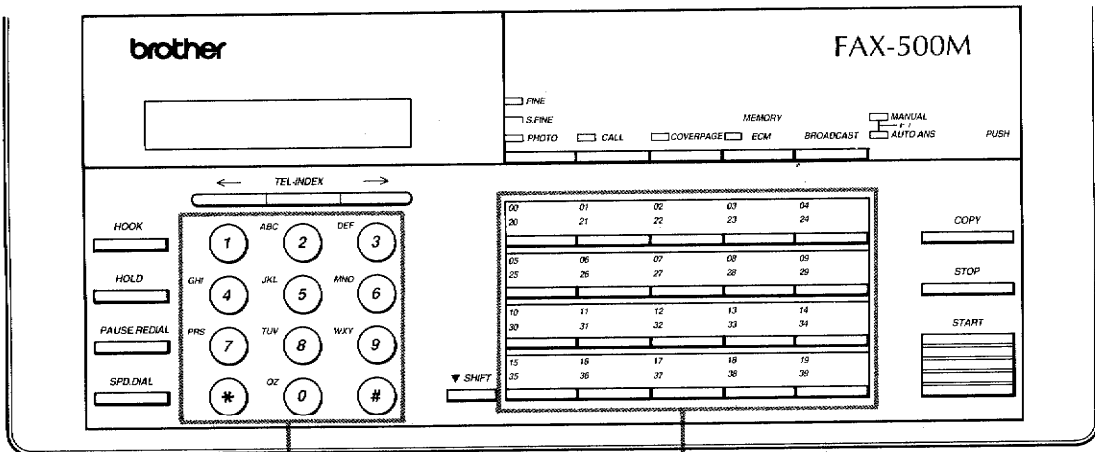
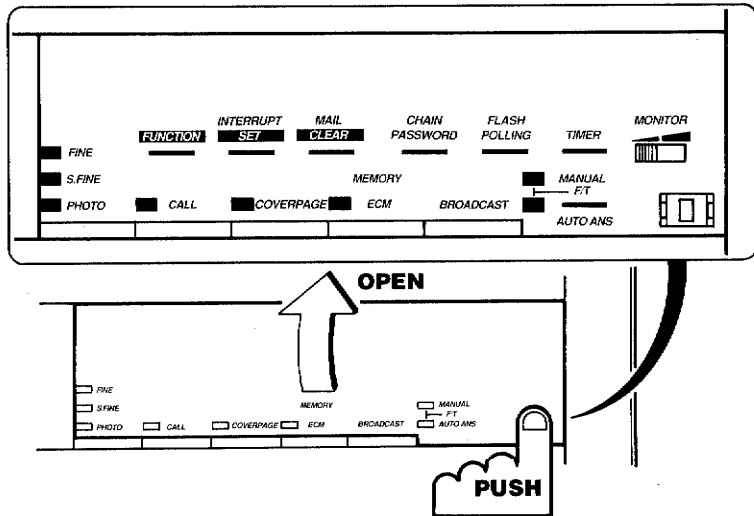









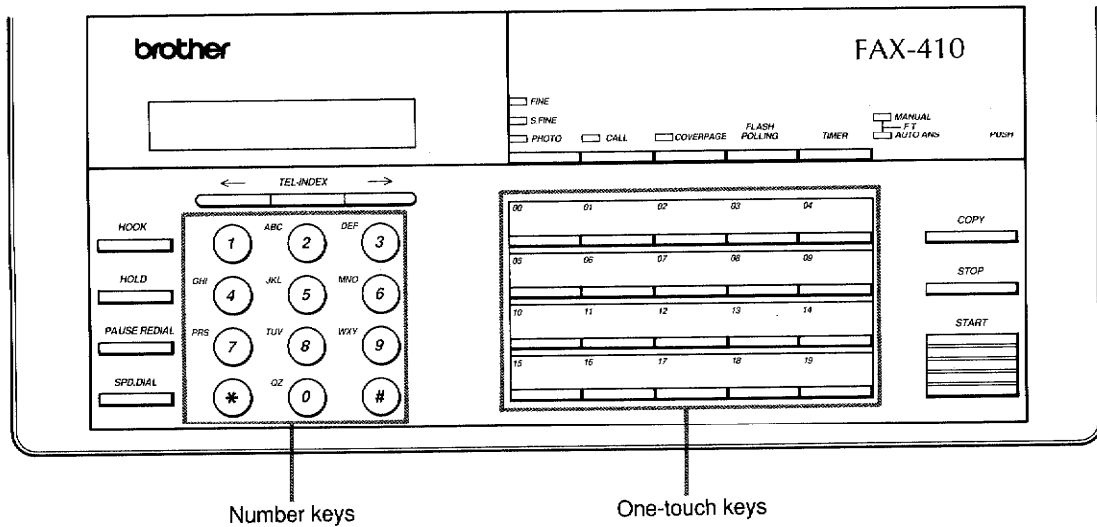
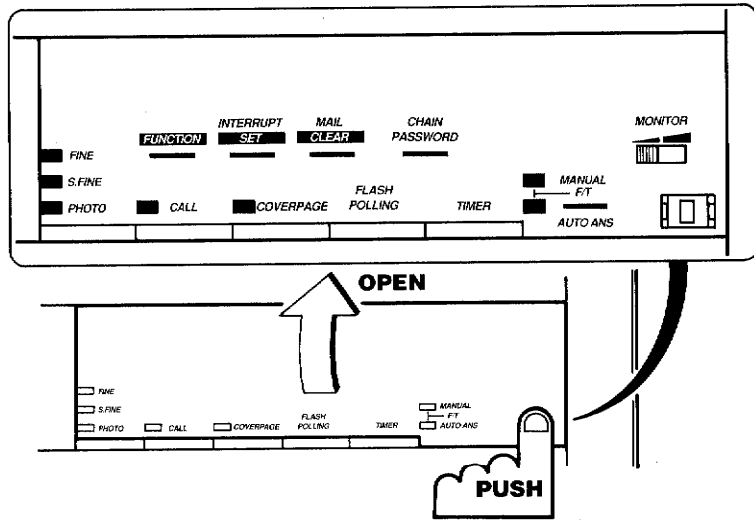

Number keys

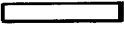
One-touch keys

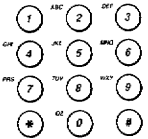
II-3. THE CONTROL PANEL KEYS



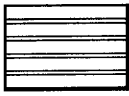





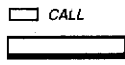
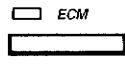

FAX-410



Key	Explanation
<p>TEL-INDEX</p> 	<p>Used when dialing to select a number stored in the unit memory. (This cannot be used for broadcasting or sequential polling.)</p>
<p>PAUSE/REDIAL</p> 	<p>Used to redial the number dialed most recently. This key is also used to insert a delay during manual dialing or when registering a one-touch or speed dialing number. (Only one pause can be entered in each number to be dialing.)</p>
<p>HOLD</p> 	<p>Used to put an in-coming call on hold. (Pressing this key a second time will cancel the hold status.)</p>
<p>SPD.DIAL</p> 	<p>Used to select a previously registered speed dial number by pressing the appropriate two-digit combination. (This key must be pressed prior to entering the two-digit speed dialing combination you wish to contact.)</p>
	<p>Used to enter any FAX/TEL number during manual dialing, and for entering a number when making registrations settings, and when searching through the Telephone Index. These keys are also used to enter names--each key corresponds to 2 or 3 letters of the alphabet. The "1", " * " and "#" keys can be used for entering special characters, punctuation marks, and symbols. (Pressing the "#" key is used to change to "tone" while "pulse" setting.)</p>
	<p>Used to move the cursor left or right when typing in names and numbers or settings. Also used to scroll forwards or backwards through the Telephone Index. In function menu, used to scroll forwards by pressing (→) cursor key.</p>
	<p>Used to select the resolution level before pressing the START key or the COPY key. (Either S.FINE or PHOTO can be selected when making copies.)</p>
<p>COPY</p> 	<p>Used to start copying operations.</p>
<p>STOP</p> 	<p>Used to stop the transmission, to cancel all current settings, and to cancel any function setting operations underway. After this key has been pressed, the LCD returns to the original display. (This key cannot be used to stop reception of documents or phone calls.)</p>
<p>START</p> 	<p>Used to start a fax transmission and to print out lists and reports.</p>
<p>BROADCAST</p>  <p>(FAX-500M only)</p>	<p>Used to send a fax transmission to several destinations or to poll several stations. (This key cannot be used for turn-around polling.)</p>
<p>COVERPAGE</p> 	<p>Used to send a super COVERPAGE with your fax transmission.</p>

Continued on next page

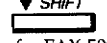
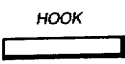
II-3. THE CONTROL PANEL KEYS

Key	Explanation
	Used to enable the Call Reservation feature.
<p>MEMORY</p>  <p>(only for FAX-500M)</p>	Used to read a document into the machine's memory. You can also use this key to select the ECM (Error Correction Mode).
	Used to confirm a function setting, or to interrupt a transmission operation.
	Used to restore existing function settings, and to delete numbers or letters during the registration of one-touch and speed dialing numbers, etc. Pressing this key with the cursor located at the beginning of a one touch or speed dialing number will clear the number which has been registered. This key is also used to obtain information and data from the confidential mailboxes available on the FAX-500M.
	Used to enable various functions in the machine.
	Used to select the fax reception mode from among the following options--Auto Answer reception mode, manual reception mode, or the FAX/TEL mode. The LED will light to indicate the current status.
	Used to set a time for a delayed transmission or delayed polling.
	Used to poll (or to be polled by) a remote unit for a document. This key is also used to transfer an in-coming call to another extension.
	Used to send a fax with a password. This key is also used for chain dialing when registering FAX/TEL numbers for one-touch or speed dialing.
	Used to dial phone numbers that you have previously registered.
<p>▼ SHIFT</p>  <p>(only for FAX-500M)</p>	Used to access an extra series of fax or phone numbers for any of the one touch keys. (For example, shift key + "00" will dial the number "20".)
	Used to dial telephone or fax number without lifting the handset.
	Used to control speaker monitor volume. (high and low)
	Ring volume control of handset. (High, middle, or low) This control is on the left side of the handset base.

4. FUNCTIONS

Pressing the **FUNCTION** key will bring the primary function menu items up on the LCD one at a time. The unit will scroll through all of the first level items automatically. The (→) cursor key can be used to scroll through this list of items quickly.

First level function items are as follows:

1. ONE-TOUCH/SPEED DIAL
2. REGISTRATION
3. Not Used
4. LISTS AND REPORTS
5. USER OPTIONS
6. CURRENT SETTINGS
7. CONFIDENTIAL MAIL BOX (only for FAX-500M)
8. RELAY BROADCAST (only for FAX-500M)
9. CANCEL TRANSMISSION

Select the function you want to use by pressing the relevant number key. Your selection will appear on the LCD. After you have confirmed your choice, press the **SET** key.

After the **SET** key has been pressed, secondary items for the function you have selected will appear on the LCD. The procedure for choosing a secondary item is the same as that for selecting a primary function. These menu items and brief explanations are provided below.

1. ONE-TOUCH/SPEED DIAL

Number	Menu	Explanation	cf.
1	ONE-TOUCH DIAL	Registering/Changing/Erasing one-touch dial	IV-4-1
2	SPEED DIAL	Registering/Changing/Erasing speed dial	IV-5-1

II-4. FUNCTIONS

2. REGISTRATION

Number	Menu	Explanation	cf.
01	COVERPAGE COMMENT	Registering/Changing/Erasing coverpage user comment for super COVERPAGE	V-4-3
02	DATE-TIME	Setting/Changing date and time for the unit's clock	IV-1-1
03	INITIAL TIMER	Setting/Changing initial timer	V-6-3
04	F/T & REMOTE ID	Setting/Changing fax/tel and remote activation ID	IV-3-3
05	STATION ID	Setting/Changing machine ID	IV-1-2
06	RECEIVE PASSWORD	Setting/Changing password for the unit	V-7-2
07	RELAY ID (only for FAX-500M)	Setting/Changing ID for relay broadcasting	V-12-2
08	CONFIDENTIAL (only for FAX-500M)	Registering/Changing confidential mail box (Name, retrieval ID, and conf. ID)	V-13-1
09	GROUPING (only for FAX-500M)	Registering/Changing group dialing	IV-4-3
10	NOT USED		
11	NOT USED		
12	NOT USED		

- Be sure to use two digits numbers when entering the numbers shown above. (EX. For "01 COVERPAGE COMMENT", press the "0" key followed by the "1" key.)

3. NOT USED

4. LISTS AND REPORTS

Number	Menu	Explanation	cf.
1	ALL DIAL	Printing out both one-touch and speed dial list at once	V-18-1
2	ONE-TOUCH DIAL	Printing out one-touch dial list	IV-4-4
3	SPEED DIAL	Printing out speed dial list	IV-5-2
4	TEL-INDEX	Printing out telephone index list	IV-7-2
5	COVERPAGE	Printing out super COVERPAGE format	V-4-2
6	CALL BACK MSG	Printing out Call Back Message format	V-5-2
7	USER OPTIONS	Printing out user options list	V-18-2
8	MEMORY STATUS (only for FAX-500M)	Printing out memory status list	V-9-2

5. USER OPTIONS

Number	Menu	Explanation	cf.
01	RING DELAY	Setting/Changing ring delay shorter (1 ring/longer (4 rings)	IV-1-10
02	TONE/PULSE	Setting/Changing tone or pulse for telephone line	IV-1-6
03	AUTO REDIAL	Setting/Changing auto redial on or off	IV-1-10
04	XMT VERIFICATION REPORT	Setting/Changing transmission verification report on or off	IV-1-12
05	F/T RING TIME	Setting/Changing the period of pseudo-ring back tone	IV-1-9
06	BEEPER	Setting/Changing the beeper on or off	IV-1-11
07	PASSWORD PROTECTION	Setting password protection on or off	V-7-2
08	SMOOTHING	Setting smoothing on or off	V-3-1
09	NOT USED		
10	NOT USED		
11	NOT USED		
12	NOT USED		

- Be sure to use two digits numbers when entering the numbers shown above. (EX. For "01 RING DELAY", press the "0" key followed by the "1" key.)

6. CURRENT SETTINGS

Number	Menu	Explanation	cf.
1	CONTRAST	Setting current contrast to super light or auto mode	V-2-1
2	RESOLUTION	Setting resolution (Standard/Fine/Super fine/Photo) for each pages up to 30 pages	V-1-2

7. CONFIDENTIAL MAIL BOX (only for FAX-500M)

Number	Menu	Explanation	cf.
1	CONF. TRANSMIT	Sending confidential mail to another Brother machine	V-13-5
2	CONF. PRINT OUT	Printing out confidential mail from the memory	V-13-4
3	REMOTE RETRIEVAL	Retrieving (polling) confidential mail which is in another Brother machine	V-13-6

II-4. FUNCTIONS

8. RELAY BROADCAST (only for FAX-500M)

Requesting the set up of a relay broadcast with a distant relay terminal. (cf. V-12-1)

9. CANCEL TRANSMISSION

Used to cancel transmission or polling operations which have already been programmed.
(cf. V-16-1)

III. Setting up

1. SELECTING A LOCATION FOR YOUR FAX MACHINE

The following points should be kept in mind when selecting a place to set up your fax machine.

- Place the fax machine on a flat, stable surface such as a desk or stand.
- Select a place where the machine will not be subjected to bumping or excessive vibration.
- Do not set it up in a high-traffic area.
- Locate the unit near a telephone wall jack and a standard grounded outlet.
- Avoid setting up the machine near heaters, air conditioners, water, chemicals or refrigerators.
- Avoid direct sunlight, excessive heat, moisture, or dust.
- Do not connect the unit to electrical outlets controlled by wall switches or automatic timers. Disruption of power can wipe out information in the unit's memory.
- Do not connect the unit to electrical outlets on the same circuit as large appliances and other equipment that might disturb the power supply.
- Avoid interference sources, such as loudspeakers or the base units of cordless telephones.
- Be sure to disconnect the handset when moving the unit.

2. UNPACKING THE MACHINE

Unpack the unit and accessories from the box. Check that you have all the items shown in the illustration below.

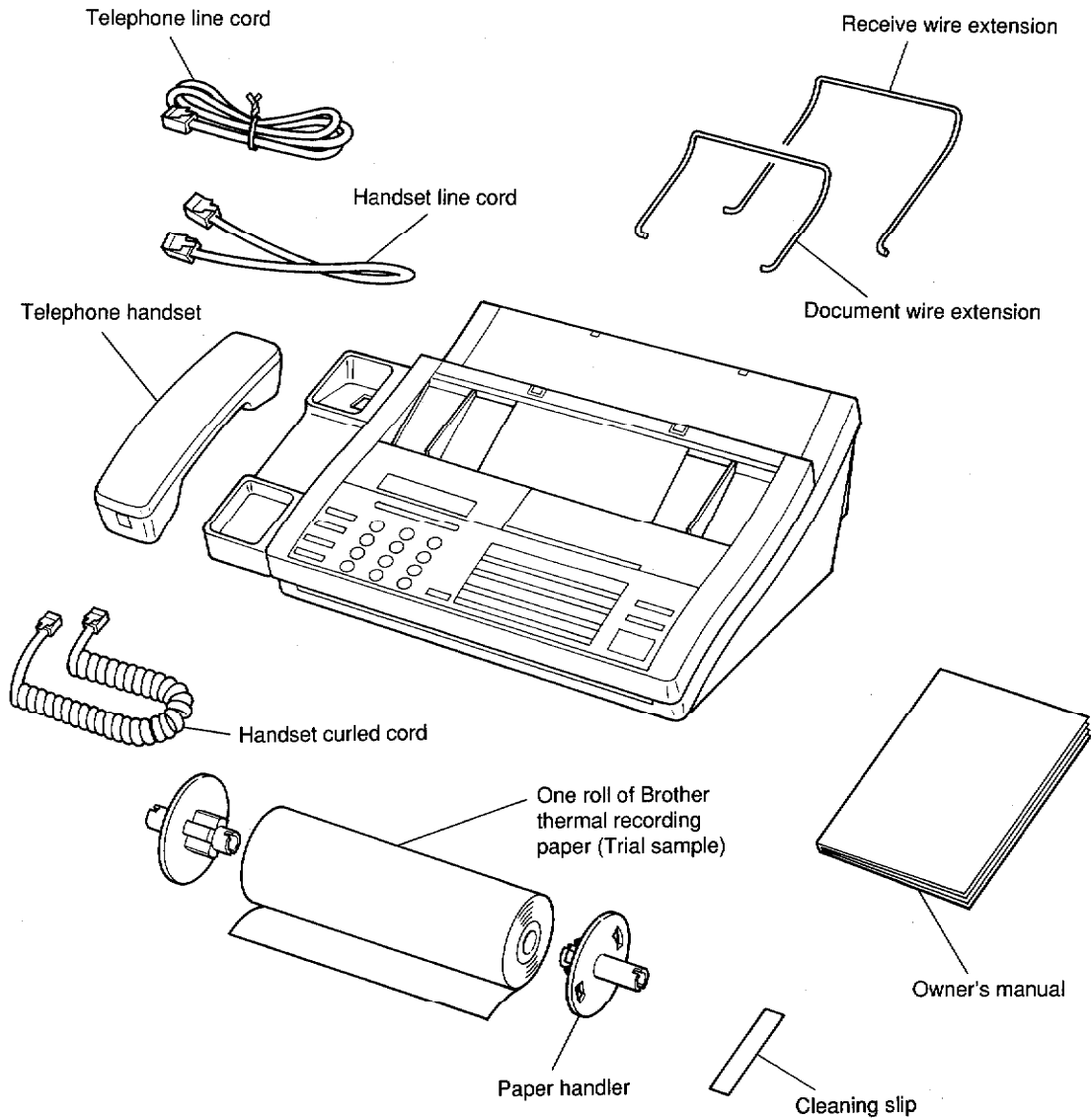

3. CONNECTING THE HANDSET

- 1) Insert the handset line cord into the base of the handset as shown. Listen for the click which will indicate that the plug is securely in position.

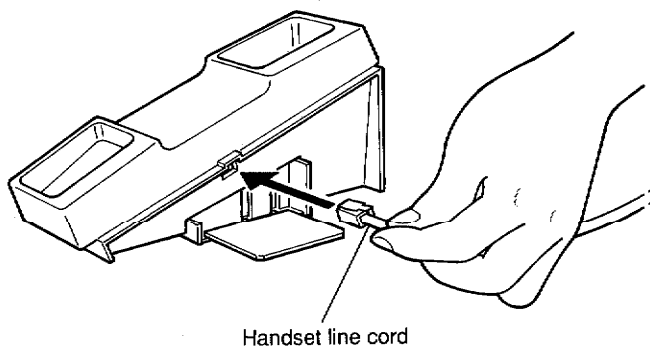

- 2) Draw the handset line cord through the gap provided to prevent the cord from being pinched between the base and the fax unit. Set the fax unit on its side, so the slot for sliding the handset base into position is accessible. Insert the handset into the slot provided. Insert until the handset base is fixed in position.

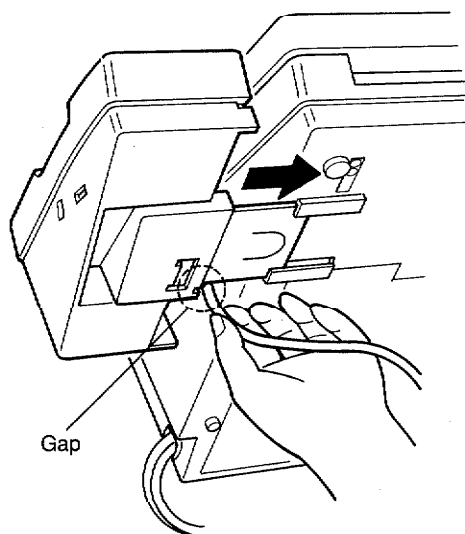

III-3. ASSEMBLING THE HANDSET

- 3) Insert the remaining end of the handset line cord into the "HANDSET BASE" socket located at the rear of the machine. Again, listen for the click when inserting the plug into the socket.

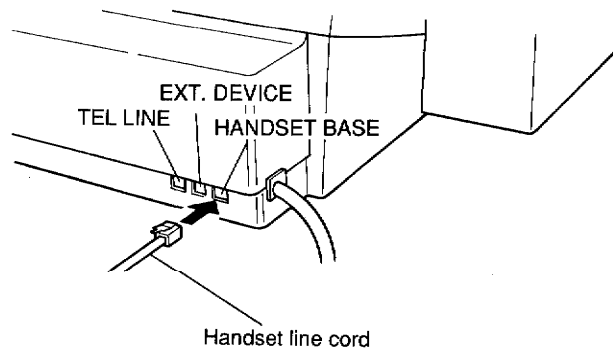

- 4) Insert the curled cord into the base of the handset as illustrated.

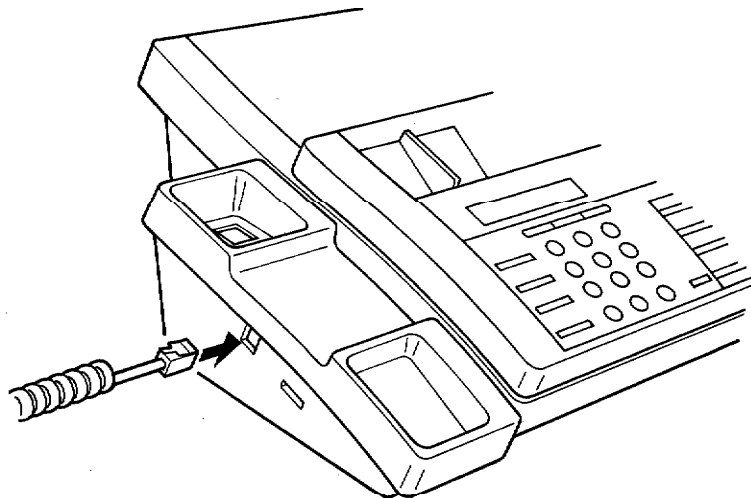

- 5) Insert the other end of the curled cord into the handset itself. A click will sound when the plug is in position.

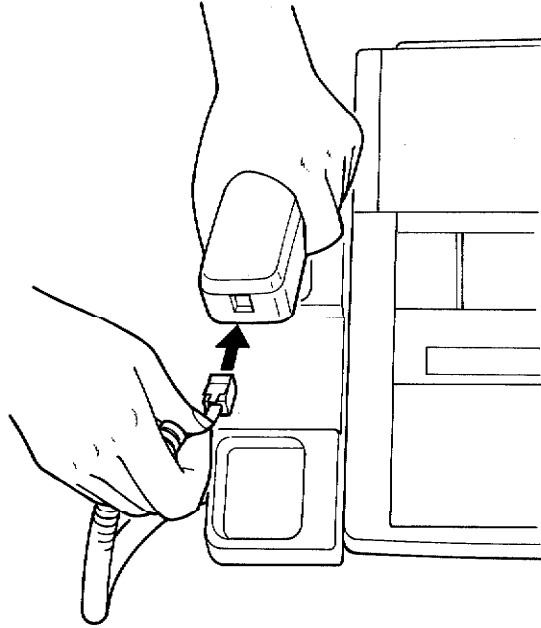

4. INSTALLING THE WIRE EXTENSIONS

- 1) Pinch the ends of the receive wire extension together slightly and insert the prongs into the holes provided at the rear of the machine as shown in the illustration.
- 2) Pull the ends of the document wire extension apart slightly and insert them into the holes provided on the machine as shown in the illustration.

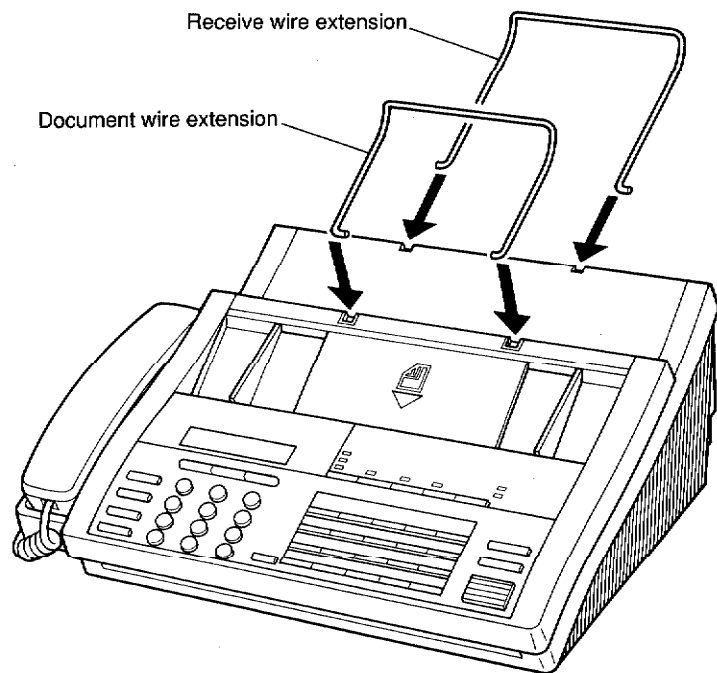

- Install the wire extensions with the curved parts of the wire extension pointing upward.

5. LOADING PAPER

- 1) Set your fingers at fingering slots provided at either side under the tray used for inserting original documents. Lift up on the tray to open the machine as shown in the illustration.

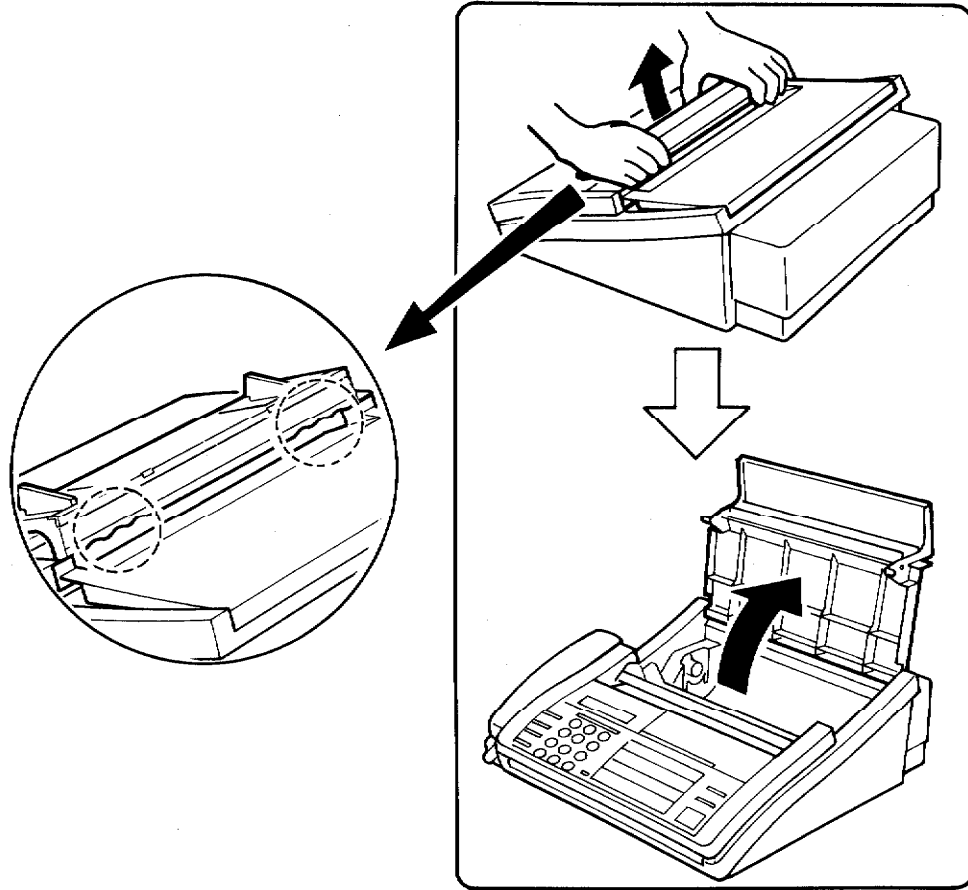

III. Setting up

III-5. LOADING PAPER

- 2) Insert the plastic paper handlers into the ends of the tube holding the paper. (When replacing an empty paper roll, be sure not to lose track of these paper handlers, as they are necessary for fitting the roll into place in the machine.)

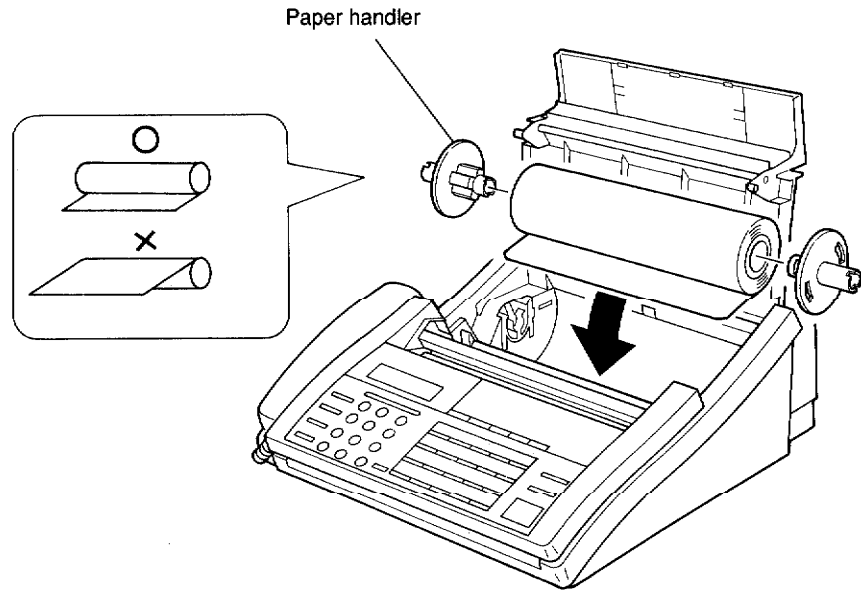

- 3) Load the roll of paper into the machine, inserting the paper handlers so they fit firmly into the sockets provided, as shown in the illustration. Check to be sure the paper is coming off the roll correctly, from the bottom, not from the top of the roll.

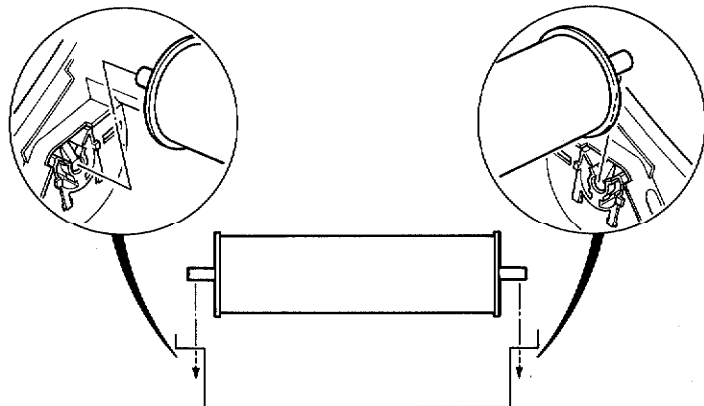

- 4) Pull the paper evenly away from the roll, and insert it between the metal guide and the plastic ribs located below the metal guide. Check the paper as it leads from the roll into the guide to be sure there is not too much tension nor too much slack in the paper.

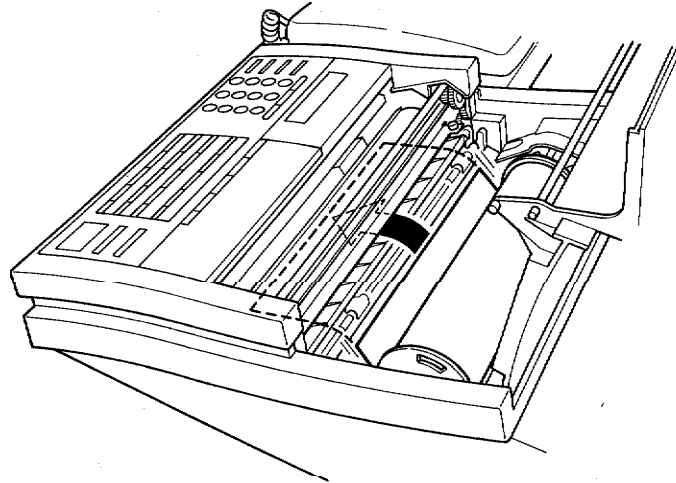

III. Setting up

- 5) Close the cover.

Note:

Be sure not to mistakenly push the release levers for the cover down into the lower position. These release levers must be in the upper position (as shown in the illustration provided) or the machine will not close properly.

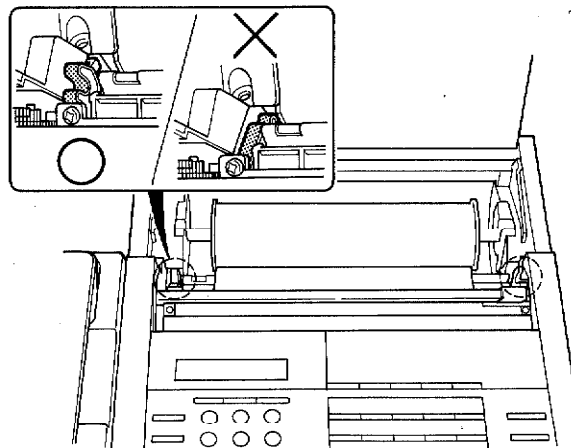

Note:

If you have inserted the plug into the power supply before you have loaded the machine with paper, an alarm will sound and a CHECK RECORDING PAPER message will appear on the screen.

Note:

- *Use 1" core thermal Roll paper.
(You may experience some difficulty if you try to use paper of less than 1" core.)*

6. CONNECTING YOUR FAX TO THE POWER OUTLET

Important

The machine must always be connected to the power outlet before you connect it to a telephone line.

Similarly, when moving the unit, the telephone line connection should be removed before unplugging the power cord. This is because the machine relies on the ground from the plug to protect you from any hazardous electrical conditions occurring on the telephone network.

This machine can be plugged into any standard grounded power outlet. Make sure the socket is grounded and that it is not on the same line as any large appliances or office machines such as refrigerators or photocopiers. The power requirements for this fax machine can be found in the *Specifications* section on page VIII-8-1.

There is no ON/OFF switch. When the machine is plugged in, the date/time display appears on the LCD. You can set the correct time and date on this display by following the instructions on page IV-4-1 in the section *Configuring the machine*.

- *When the machine is plugged in, the recording paper will be fed through the automatically.*

7. CONNECTING TO A TELEPHONE LINE

If you plan to use a single telephone line connection follow the instructions below. This is straightforward if your telephone receiver is connected using modular telephone jacks.

- 1) Plug one end of the telephone line cord into the back of the fax machine. Use the TEL LINE socket located farthest to the left.
- 2) Plug the other end of the cord into the telephone wall jack socket. Make sure this end clicks into place.

Jacks

If you have the older 4-prong telephone wall jack, you must use a modular 4-prong adapter (USOC RJA1X). Plug the adapter into the wall jack and then plug the telephone cord into the adapter, as shown in the illustration below.

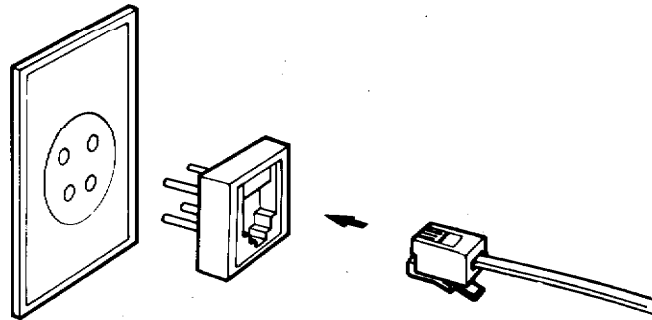

Multi Line Connections (PBXs)

Most offices use a central telephone system. While it is often relatively simple to connect the machine to a key system or a PBX (private branch exchange), we suggest that you contact the company which installed your telephone system and ask them to connect the fax machine for you.

It is advisable to have a separate line for the fax machine. You can then leave the machine in AUTO ANSWER mode to receive faxes at any time of the day or night.

If the fax machine is to be connected to a multi-line system, ask your installer to connect the unit to the last line on the system. This will prevent the unit from being activated each time a telephone call is received.

- *If you have call waiting, ring master, or any other custom calling feature on your telephone line it may create a problem in the operation of your fax unit.*
- *As with all fax units this machine must be connected to a two wire system. If your line has more than two wires proper connection of the fax machine can not be made.*

Connecting to a private branch exchange

The following points should be kept in mind if you are installing the machine to work with a private branch exchange (PBX).

- 1) It is not guaranteed that the unit will operate correctly under all circumstances with approved PBXs. Any cases of difficulty should be reported first to your Brother dealer.
- 2) If all incoming calls will be answered by a switchboard operator, it is recommended that the AUTO ANSWER function be set to be manual. (see page IV-1-7) All incoming calls should initially be regarded as telephone calls.
- 3) The unit may be used with either the pulse or tone dialing telephone types.

8. MAKING A TRIAL COPY

Now that your fax machine is ready for use, it is a good idea to test it by making a copy.

You can copy any document up to 8.5 inches/216 mm (A4 size) wide. Follow the instructions below.



- 1) Set the document face down into the feeder. Adjust the guides located on either side of the document if it is less than 8.5 inches wide.
- 2) The following display appears on the LCD screen.

FAX	:	ENTER FAX NO.
COPY	:	PRESS COPY KEY

- 3) Press the COPY key. The fax machine draws the original through and prints a copy.

The default setting for making copies is SUPER FINE. To change this setting when copying photographs, press the RESOLUTION key to light "PHOTO" LED, then press the COPY key.

Note:

- When the copy has been printed, the automatic paper cutter will cut the page from the paper roll.
- The machine cannot read text or images closer than 4mm to any edge of the document.
- Do not pull on the paper while copying is in progress. This may ruin the copied image.

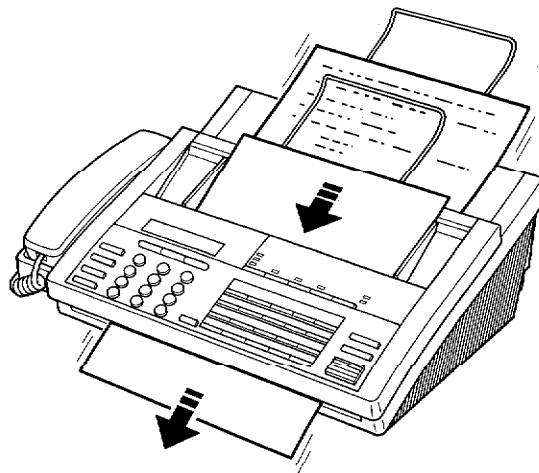

9. ADDITIONAL SET-UP OPTIONS

Connecting to an external telephone

Connect an external telephone to the "EXT. DEVICE" jack as shown.

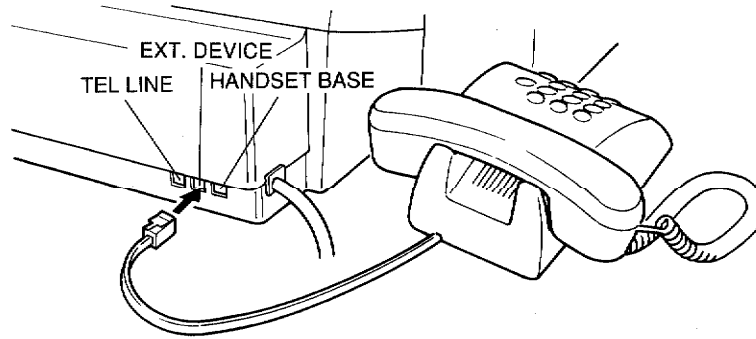

III. Setting up

You can remotely activate the machine using your external telephone. This is described in the sub-section "Reception by Enhanced Remote Activation" (see page IV-3-2).

Installing the one-touch dial label

Locate the one-touch dial label as shown in the diagram below and cover it with the plastic sheet.

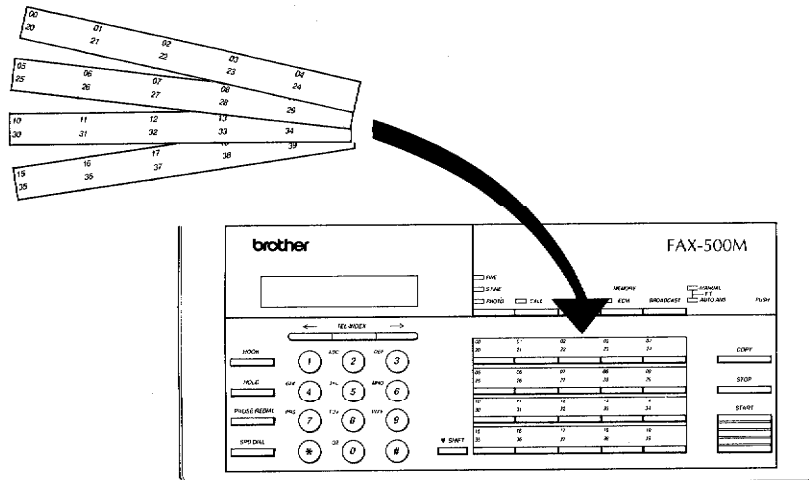

IV. Basic uses

This chapter describes the most common operations that you will perform with your fax machine, such as sending and receiving faxes, and using the one-touch, speed dial, and Telephone Index dial facilities that allow you to recall and dial regularly used fax numbers.

1. CONFIGURING THE MACHINE



When you first plug in the power cord to the outlet the following text should appear on the LCD screen:
(Make sure there is no document in the feeder.)

WARMING UP
PLEASE WAIT

01/01/1991 00:00
FAX/COPY : SET DOC.

Setting the date and time

Carry out the procedure described below to set the correct date and time for the machine.



ABC

2

- 1) Press the **FUNCTION** key. Then press the **2** key on the number keys.

2. REGISTRATION
PRESS SET KEY



QZ

0

- 2) Press the **SET** key. Then press the **0** key followed by the **2** key.

02. DATE-TIME
PRESS SET KEY

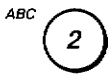

ABC

2

- 3) Press the **SET** key.

YEAR : XX
INPUT / PRESS SET TO END

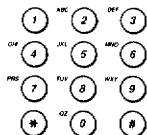

- 4) Enter the last two digits of the current year (for example enter 1991 as "91") using the number keys and then press the **SET** key.

MONTH : XX
INPUT / PRESS SET TO END



IV-1. CONFIGURING THE MACHINE

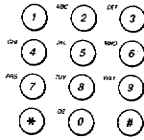

- 5) Enter the current month as a 2-digit number (for example enter July as "07") using the number keys. When you have correctly set the month press the SET key.

DAY : XX
INPUT / PRESS SET TO END

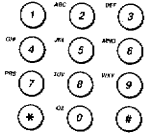

- 6) Enter the day, also as a 2-digit number (for example enter 1st as "01") in the same way as you entered the year and month. When you have correctly set the day press the SET key.

TIME : XX:XX
INPUT / PRESS SET TO END

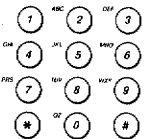

- 7) Now enter the current time in hours and minutes using the number keys. When you have correctly set the time press the SET key. The date and time that you have just set are briefly displayed and then the screen starts scrolling through the registrations' menu.

- *When setting the time*

Remember that the machine uses the 24 hour clock

- *If the power is cut off*

Should the power outlet for the unit be cut off, the date and time setting will be backed up within one hour. After one hour, the date and time setting will be cleared.

Registering your name and number

To store your name and fax number in the machine so that they will be automatically printed (along with the page number) at the top of each page of every document that you send, proceed as follows:



- 1) Press the FUNCTION key.

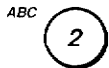

- 2) Then press the 2 key on the number keys.

2. REGISTRATION
PRESS SET KEY



- 3) Press the SET key. Then press the 0 key followed by the 5 key.

05. STATION ID
PRESS SET KEY





4) Press the SET key.

FAX: _
INPUT / PRESS SET TO END

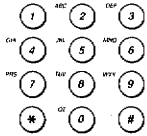

5) Enter your fax number (which can be up to 20 digits long) using the number keys. The procedure for entering numbers is described in detail in the section *Entering information using keys* in this chapter.



6) Press the SET key when you have entered the fax number correctly.

If you wish to input a "+" (INTERNATIONAL DIALING CODE PREFIX) at the first position, press the "Chain" key and continue to enter the number, using the correct international dialing code, and omitting any "ZERO" at the beginning of the national area dialing code.

TEL: _
INPUT / PRESS SET TO END

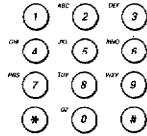

7) Now enter your telephone number (which can be up to 20 digits long) using the number keys.



8) Press the SET key when you have entered the telephone number correctly.

NAME: _
INPUT / PRESS SET TO END

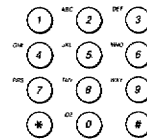

9) Enter the name you wish to appear on the faxes that you send using the number keys. The name can be up to 20 letters long including spaces. The procedure for entering names is described in detail in the section *Entering information using keys* in this chapter.



10) Press the SET key when you have entered your name.

- The telephone number is only used for the Call Back Message, super COVERPAGE.
- If you do not enter a fax number you cannot enter anything else.
- You cannot enter a "-" using the PAUSE key when registering your fax and telephone number. Use the (←/→) cursor key instead to enter a space. It will be printed as "-", but not be displayed.

IV-1. CONFIGURING THE MACHINE

Entering information using the keys

The way in which you enter numbers and names into the machine's memory is the same in all cases.

Entering numbers

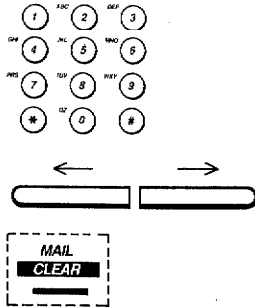

To enter a number into the machine, simply type in the number using the number keys. A horizontal cursor marks the place where the next digit you enter will be. Every time that you enter a digit, the cursor is moved one place to the right. You can also move the cursor left or right using the (←/→) cursor keys.

Press the CLEAR key to delete the number indicated by the cursor position, and all numbers to the right of the cursor.

To modify an existing digit, use the (←/→) cursor keys to move the cursor to the position you want to modify, and input a new digit over the old one.

- You cannot insert a space into a number that has been input. You must re-enter it with the space included.
- If you do not press any key for one minute, or if you press the STOP key, any changes you have made are disregarded and the original number is retained.

Entering names

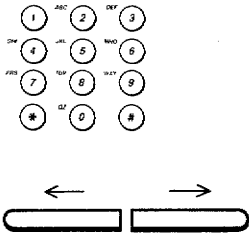

To enter names, use the keys on the number keys and (←/→) cursor keys.

Either two or three letters are assigned to each key on the number keys. Also, although they are not marked, some special characters, punctuation marks and symbols are assigned to the keys "1" key, "*" key, and "#" key.

"1"key Ä Ë Ö Ü Æ Ø Å Ñ 1
 "2"key A B C 2
 "3"key D E F 3
 "4"key G H I 4
 "5"key J K L 5
 "6"key M N O 6
 "7"key P R S 7
 "8"key T U V 8
 "9"key W X Y 9
 "0" key Q Z 0
 "*" □ ! " # \$ % & ' () * + , - . /
 "#"key : ; < = > ? @ [] ^ _

To enter any character press the appropriate key until the character appears.

DEF 

- 1) For example, to enter the name "Fred!", press the 3 key three times.

```
NAME: F
INPUT / PRESS SET TO END
```

PRS 

- 2) Press the 7 key twice.

```
NAME: FR 
INPUT / PRESS SET TO END
```

DEF 

- 3) Press the 3 key twice.

```
NAME: FRE 
INPUT / PRESS SET TO END
```

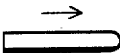

- 4) Press the (→) cursor key once to move the cursor to right.

- To enter successive characters which are assigned to the same key, you must use the cursor key to move the cursor to the right.

```
NAME: FRE 
INPUT / PRESS SET TO END
```

DEF 

- 5) Press the 3 key once.

```
NAME: FRED 
INPUT / PRESS SET TO END
```



- 6) Press the * key twice.

*- When you press the 1 key, * key, or # key, the lower line of the screen shows the characters assigned to that key. Press the key n times to use the nth character in the row.*

```
NAME: FRED! 
MARK- 1"#$%&'()*+,-./
```



- 7) Press the SET key.

IV-1. CONFIGURING THE MACHINE

Note:

- You can only overwrite characters. Insertions cannot be made.
- You can overwrite with a space by pressing the * key once.
- If you want to change a character, use the (←/→) cursor keys to move the cursor underneath the character and enter a new character.
- Press the CLEAR key to delete the character indicated by the cursor position, and all characters to the right of the cursor.

Selecting tone or pulse dialing

There are two different dial types, and you must select the type of signal suitable for your telephone line.

The default setting is "Tone".

- 1) Press the FUNCTION key. Then press the 5 key on the number keys.



```
5.USER OPTIONS
PRESS SET KEY
```

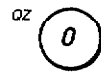

- 2) Press the SET key. Then press the 0 key followed by the 2 key.

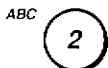

```
02.TONE-PULSE
PRESS SET KEY
```



- 3) Press the SET key.

```
CURRENT : TONE
1. TONE 2. PULSE
```

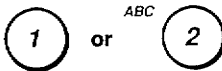

- 4) Press the 1 key for tone dialing, the 2 key for pulse dialing.

```
TONE-PULSE : PULSE
PRESS SET KEY
```



- 5) Press the SET key to confirm your selection.

Setting the auto answer switch



You can select answering mode for fax reception – your choice are automatically, manually, or FAX/TEL auto switching.

You can set the unit to answer in-coming calls automatically by turning on the auto answer feature. To do this, press the AUTO ANS. key to light the AUTO ANS LED.



If you want all calls to be answered manually, press the AUTO ANS key to light the MANUAL LED.



If you want to select FAX/TEL, Auto changing switch, press the AUTO ANS. key, and light both the AUTO ANS. and MANUAL LEDs.

The initial setting is "Auto Ans."

FAX/TEL switch

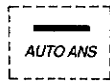

The unit is equipped with a switching feature that can distinguish between telephone calls and fax transmissions. Improving communications when the machine is used on a single telephone line. To activate this function on your machine, press the AUTO ANS key until both LEDs are lit the AUTO ANS and MANUAL LEDs.

If the other party is sending an automatic transmission, the unit detects the CNG tone and enters fax reception mode automatically.

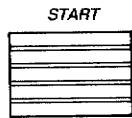

If the other party is sending a manual transmission or telephone call the unit rings for a specified period (10 or 20 or 30 seconds which you can select as the F/T ringing time). Within the F/T ringing time, if you pick up the handset, you can talk with the other party. When the other party wants to send a manual transmission, press the START key and you will receive the document. If you cannot pick up the handset within the F/T ringing time, the unit will enter FAX reception mode automatically. So you can receive a document by manual transmission even if you are away from the machine.

Also, if you have given your F/T & Remote ID number to the other party they can always send a manual transmission and put your machine into FAX reception mode by entering the ID number (only using a tone dial unit). (see F/T & remote ID)

IV. Basic Uses

IV-1. CONFIGURING THE MACHINE

The following flow chart illustrates the situations which may arise in the operation of the FAX/TEL switch on the unit.

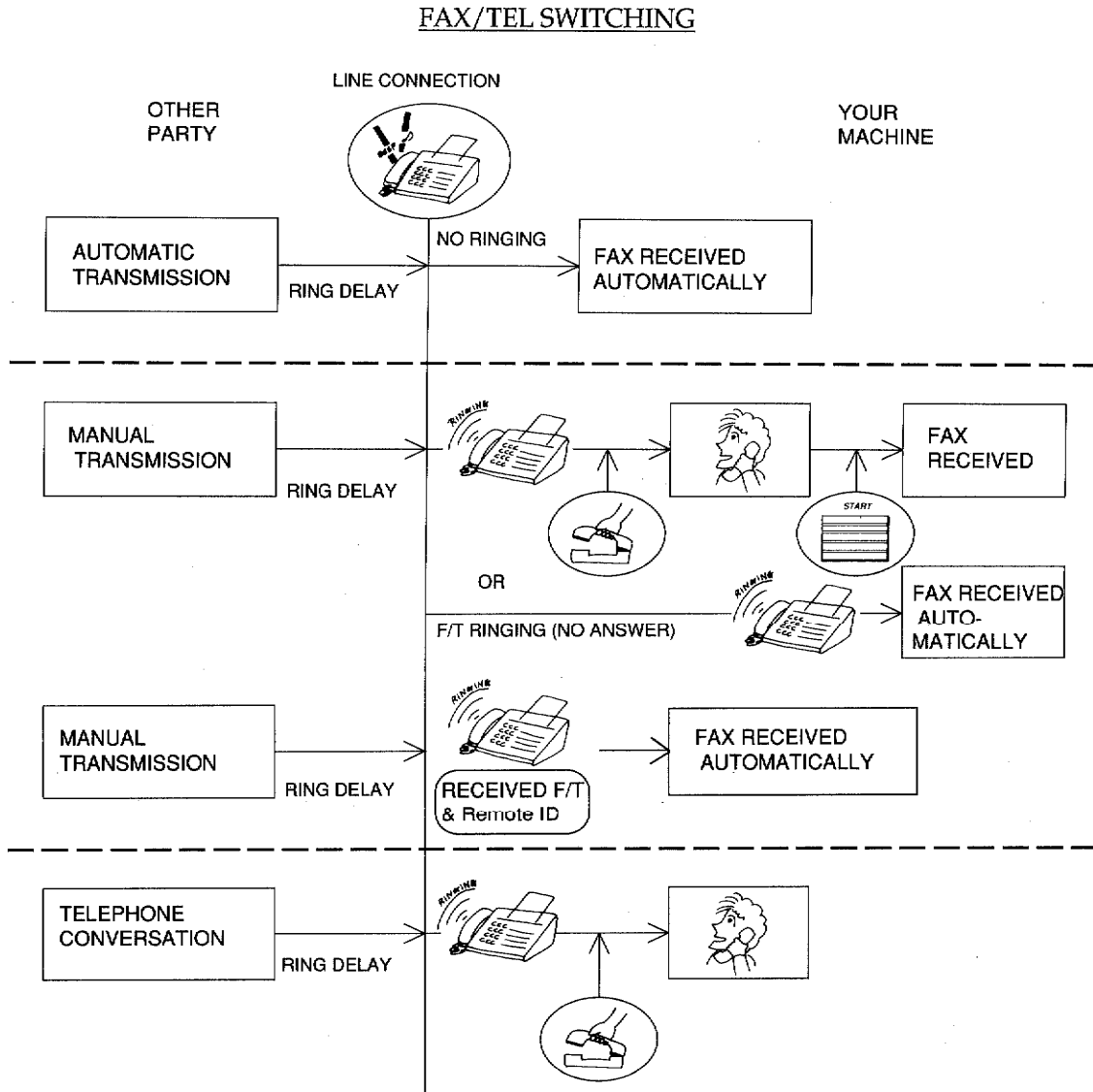

RING DELAY : This refers to the number of rings before the phone line is connected in response to a telephone call or fax transmission. You have the option of setting this to either 1 or 4 rings.

F/T RINGING : After the line is connected, the machine begins to ring a second time, for a selectable period of 10, 20 or 30 seconds. This additional ringing period provides you with extra time to pick up the telephone for a phone conversation or to receive the manual transmission of a fax. During this period, the other party can hear "pseudo-ring" back tone.

- The cost of the transmission (borne by the sending party) will be calculated from the point in time at which the beep signals that the line connection has been made.
- After beep signal, there is no sound about for 4 seconds to detect a CNG which is sent by other party, until the line is disconnected.

Setting the F/T ringing period

You can select the F/T Ringing period by following the procedure below.

- The initial setting is 30 seconds.



JKL (5)

- 1) Press the FUNCTION key. Then press the 5 key.

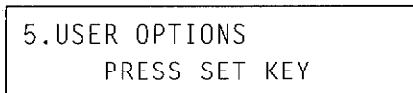

OZ (0)

- 2) Press the SET key. Then press the 0 key followed by the 5 key.

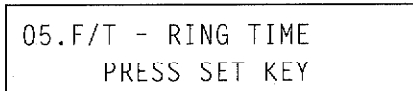

JKL (5)

- 3) Press the SET key.

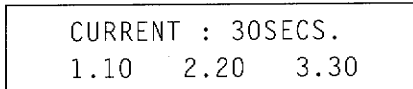

(1) , (2) ABC

- 4) Press the 1 key to select 10 seconds, the 2 key for 20 seconds, or the 3 key for 30 seconds.

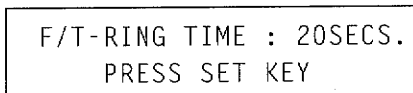

or DEF (3)



- 5) Press the SET key to confirm your selection.

IV. Basic uses

IV-1. CONFIGURING THE MACHINE

Setting the ring delay

You can select the number of times the telephone will ring before the machine will switch to reception mode.:

- *The initial setting is Longer.*



JKL (5)

- 1) Press the FUNCTION key. Then, press the 5 key on the number keys.

5.USER OPTIONS
PRESS SET KEY



OZ (0)

- 2) Press the SET key. Then, press the 0 key followed by the 1 key.

01.RING DELAY
PRESS SET KEY

(1)

- 3) Press the SET key.

CURRENT : LONGER
1.SHORTER 2.LONGER



(1)

or

ABC (2)

- 4) Press the 1 key for a shorter ring delay (1 ring), the 2 key for a longer ring delay (4 rings).

RING DELAY : SHORTER
PRESS SET KEY



- 5) Press the SET key to confirm your selection.

Turning auto redial on and off

If you are sending a fax automatically (see *Sending a fax* in this chapter) you can set up the machine to redial the number automatically if the destination number is engaged. The unit will redial the last used number up to 3 times at 5-minute intervals.

- *The initial setting is "ON".*



JKL (5)

- 1) Press the FUNCTION key. Then press the 5 key on the number keys.

5.USER OPTIONS
PRESS SET KEY



QZ 0

2) Press the SET key then the 0 key followed by the 3 key.

03.AUTO REDIAL
PRESS SET KEY

DEF 3

3) Press the SET key.

CURRENT : ON
1.ON 2.OFF



4) Press the 1 key to turn auto-redialing on, the 2 key to turn auto-redialing off.

AUTO REDIAL : OFF
PRESS SET KEY

1 or ABC 2

5) Press the SET key to confirm your selection.



Note:

- Even if auto-redial is "ON", it cannot be used to send an automatic transmission when the interrupt function has been used.
- Auto redial cannot be used for manual transmission.

Turning the beeper on and off

The unit has a beeper which sounds to indicate operating errors and when keys have been pressed. You may decide that you would rather operate the machine without this facility. To turn the beeper on or off proceed as follows.

- The initial setting is "ON".



JKL 5

1) Press the FUNCTION key. Then, press the 5 key on the number keys.

5.USER OPTIONS
PRESS SET KEY



QZ 0

2) Press the SET key. Then press the 0 key followed by the 6 key.

06.BEEPER
PRESS SET KEY

MNO 6

IV-1. CONFIGURING THE MACHINE



3) Press the SET key.

```
CURRENT: ON
1.ON 2.OFF
```

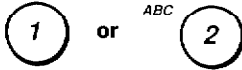

4) Press the 1 key to turn the beeper on, the 2 key to turn the beeper off.

```
BEEPER : OFF
PRESS SET KEY
```



5) Press the SET key to confirm your selection.

Turning the transmission verification report on and off

You can establish the success or failure of a fax transmission by printing out the transmission verification report. This report is automatically printed for each transmission if you turn the transmission verification feature on. If you do not want this report generated you can disable the function.

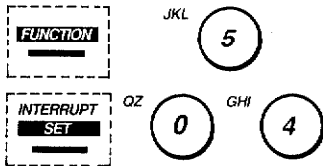

1) To turn this function on or off, press the FUNCTION key followed by the 5 key. Press SET key. Then press the 0 key followed by the 4 key.

```
04.XMT VERIFICATION
PRESS SET KEY
```



2) Press the SET key.

```
CURRENT : OFF
1.ON 2.OFF
```

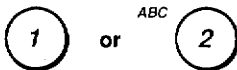

3) Press the 1 key to turn transmit verification on, or the 2 key to turn it off.

```
XMT VERIFICATION : ON
PRESS SET KEY
```



4) Press the SET key.

- *The initial setting is "OFF".*

- *When the transmission error occurred, this report is always printed out.*

TRANSMISSION VERIFICATION REPORT

TIME : 06/01/1991 14:18
NAME : BROTHER
FAX : 052-811-5981
TEL : 052-824-2554

DATE.TIME	06/01 14:16
FAX NO./NAME	HEAD QTR.
DURATION	00:01:33
PAGE (S)	01 COVERPAGE CALL BACK MSG
RESULT	OK
MODE	FINE

2. SENDING A FAX

There are two methods of sending a fax transmission - automatic and manual.

Automatic transmission

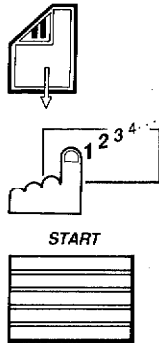

FAX : ENTER FAX NO.
COPY : PRESS COPY KEY

To transmit a document automatically, set the document face down in the document feeder. The following screen appears:

Dial the fax number of the destination using one-touch, speed dial, Telephone Index, or manual dialing. Then, press the **START** key.

The document is read through the machine automatically.

On successful completion of transmission, the machine will beep. If the transmission verification is "ON", then you will get a report at the end of each transmission.

If the telephone connection was not successful, and auto redial was set to "on", the machine will try to send again automatically. (See page IV-1-10.) If the auto redial was set to "off", the transmission will fail.

If the transmission was not successful then, the unit will print out a Transmission Verification Report (error) automatically. If the distant end is busy or there is no response the LCD will read either "NO RESPONSE OR BUSY", and the unit will print out a transmission verification Report (busy) automatically.

TRANSMISSION VERIFICATION REPORT

TIME : 06/01/1991 14:18
 NAME : BROTHER
 FAX : 052-811-5981
 TEL : 052-824-2554

DATE.TIME	06/01 14:16
FAX NO./NAME	HEAD QTR.
DURATION	00:01:33
PAGE (S)	01 COVERPAGE CALL BACK MSG.
RESULT	ERROR
MODE	FINE

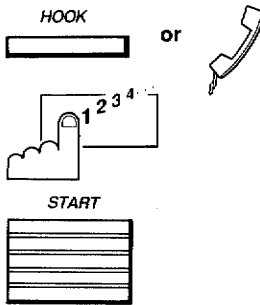
Manual transmission

To transmit a document manually, set the document face down in the document feeder. The following screen appears:

FAX : ENTER FAX NO.
COPY : PRESS COPY KEY

Either press the HOOK key or pick up the handset. Now dial the number of the destination using one-touch, speed, Telephone Index, or manual dialing. When you hear the answering fax tone press the START key and, if necessary, hang up the handset.

The document is drawn through the machine automatically.

Upon successful completion of the transmission the machine will beep.

- *Auto Redial is not effective for manual transmission.*
- *Only the following current settings are effective for manual transmission:*

- *Resolution*
- *super COVERPAGE*
- *Call Reservation*

- *In case of dialing by Telephone Index, before pressing HOOK key or picking up the handset, you should select the number from the Telephone Index. (see page IV-8-1)*

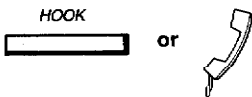
**Points to Remember When Sending a Fax**

Bear in mind the following points whenever you send a fax.

- Adjusted the guides located on either side of the document, if it is less than 8.5 inches/216 mm wide. (Min. width 5.8 inches/148 mm).
- Do not send documents on any of the following types of paper:
 - Thick paper
 - Very thin paper, such as tissue or tracing paper
 - Wet, wrinkled, torn, curled, or slick paper
 - Thick photographic or coated paper
 - Paper with tape or staples, or with metal or textiles attached

If you must send a document on any of these types of paper, copy them first with a photocopy machine and then use the copies to send your faxes. (Do not make your copies on this convenience copier, as the paper restrictions for the fax function apply to the copier as well.)

- The range of optimum thicknesses for sheets used in the ADF is 2.8×10^{-3} – 3.9×10^{-3} inches (0.07 – 0.10 mm) and the range for weight is 0.07×10^{-3} – 0.114×10^{-3} lbs/inch² (52 – 80g/m²). If you are using only one sheet of paper, the thickness of the paper should be between 2.8×10^{-3} – 3.9×10^{-3} inches (0.07 – 0.12 mm) and the weight, between 0.114×10^{-3} – 0.182×10^{-3} lbs/inch² (80 – 128g/m²).
- If the receiving fax machine is not set to AUTO ANSWER, someone may answer the telephone. If this happens, ask the other party to start fax reception by pressing their START key. (Remember you must use the handset to speak to the other party, as the unit does not have speaker phone.) Press the START key and then hang up after you hear the fax tone.
- If a document stops during feeding, press the STOP key to remove it. If the jammed paper is not ejected after pressing the STOP key, open the cover and remove the document.
- Remember that the fax machine cannot read text or images closer than 4 mm (15.74×10^{-2} inches) from any edge of a document when copying or sending a fax.
- Do not load more than 30 documents into the feeder at one time.
- Be sure to remove all paper clips before sending your document.
- Send glossy paper one page at a time.
- Do not attempt to transmit paper of differing sizes or thickness in one transmission.

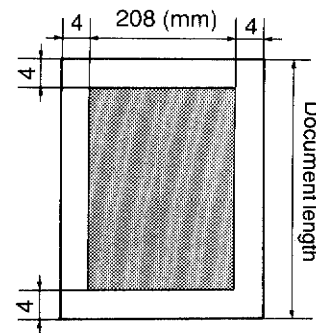

Loading multiple pages for transmitting or copying

If the document you are about to transmit or copy is more than one page, fan the sheets of paper and insert them face down, so that the first page is at the bottom and will be fed first.



Current setting for sending a fax

In order to make the clearest, most effective fax transmissions possible, the following current settings have been provided for your use. They are described in greater detail in the unit shown in parenthesis.

These current settings should be made after setting the document face down in the document feeder (if needed), but before entering the fax number.

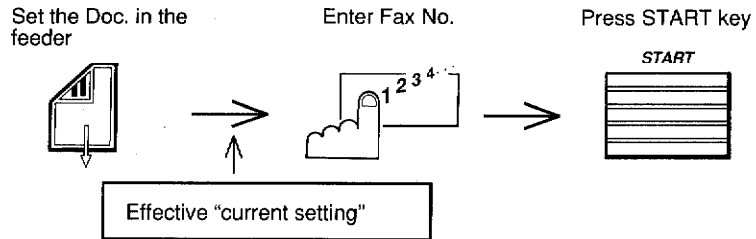

- **Resolution:** This can be changed from standard to fine (for newsprint and drawings), super fine (for highly detailed drawings), photo (for sending pictures), by pressing the resolution key. (See page V-1-1)
- **Contrast:** This can be changed automatically. If you want to send a super-light document, you can select "super light" mode manually. (see page V-2-1)
- **super COVERPAGE:** This exclusive Brother feature lets you send an extra sheet which includes your name and fax number as well as those of the destination. In addition, a message such as an "urgent!", "confidential", or your own message can be included with this information. (See page V-4-1)
- **Timer:** This option allows you to set a time at which you want your documents to be sent. This means it is possible to send a document when you are not in the office (e.g. at night when telephone rates are low). (See page V-6-1)
- **Polling:** Fax units can use this function to request documents from other units. Several sub-options are also available to let you make the most effective use of this feature. (See page V-8-1)
- **Password:** This security function lets you send and receive faxes in a closed network, and prevents reception of junk faxes. (See page V-7-1)
- **Call Reservation:** This allows telephone conversation with the other party after sending message. (See page V-5-1)
- **Relay Broadcasting (only for FAX-500M):** This allows documents to be sent to the center machine (a Brother machine with memory) for storage and relay transmission to other local machines. You can save the expense of numerous long-distance calls. (See page V-12-1)
- **Broadcasting (only for FAX-500M):** This feature can be used to send the same document to several different locations in a single operation. (See page V-11-1)

- **Memory (only for FAX-500M):** This allows you to send document(s) from memory. (see page V-9-1)
- **ECM (only for FAX-500M):** This is error correction mode which checks the integrity of a fax transmission while it is in progress and takes corrective action. (see page V-10-1)
- **Confidential mailbox (only for FAX-500M):** This allows you to send a document which will be stored in the receiving unit's memory until the receiving party inputs an access code. (See page V-13-1)

Redialing

If the number that you have dialed is engaged you can redial it without having to re-enter the number. There are two different ways of doing this, depending on whether you are using manual or automatic transmission.

Automatic redialing

Automatic redialing can only be used for faxes that were sent using automatic transmissions - not for telephone calls. You can turn automatic redialing on or off (see page IV-1-10).

When using automatic transmission to send a fax, if the destination number is engaged, the machine will automatically redial the number up to three (3) times at five (5) minutes intervals.

- *Before using automatic redialing, you can send a different fax message or make a copy of a document using the "Interrupt" feature.*

(See page V-15-1.)

- *To cancel automatic redialing, press FUNCTION key, then press the 9 key to enable the "Cancelling a Transmission" function.*

(See page V-16-1.)

Manual redialing

If you are manually sending a fax or using the unit as a telephone and you obtain a busy signal, carry out the following procedure.

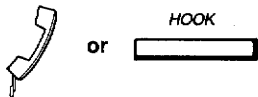
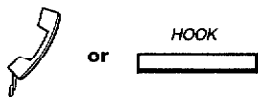

1) Replace the handset or press the HOOK key.

2) Pick up the handset or press the HOOK key.

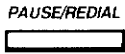

- 3) When you hear the dialing tone press the **REDIAL** key. The machine now redials the number it dialed last.

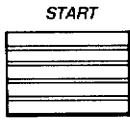

- 4) If you are sending a fax, press the **START** key when you hear the answering fax tone. If you are making a telephone call, simply proceed when the called party answers.

3. RECEIVING A FAX

Fax reception can be either manual or automatic. You will probably want to receive faxes automatically, as this is the more straightforward method. However, if you are using a single telephone line for both telephone and fax reception you will have several options. You can either use the unit in manual reception and monitor all in-coming calls, or you can use the FAX/TEL switch and let the machine decide if the call is a fax message or not.

Automatic reception



To receive faxes automatically set the AUTO ANS function to ON (the AUTO ANS LED is lit), (see page IV-1-7). There is no need for any further intervention - the machine will answer all calls automatically at any time. Having successfully received a fax the machine beeps once.

Manual reception



To receive faxes manually set the AUTO ANS function to OFF (the MANUAL LED is lit), (see page IV-1-7). The procedure for receiving a fax is as follows:

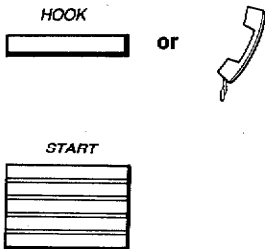

- 1) When the telephone rings either pick up the handset or press the HOOK key.
- 2) If you hear a fax tone press the START key.
- 3) Replace the handset if necessary.

Having successfully received a fax the machine will beep once.

Reception with FAX/TEL switching

There are two types of reception with FAX/TEL switching as described in the *configuration* section (see page IV-1-7) at the start of this chapter.

- 1) Automatic transmission from the other party.
 - 2) Manual transmission from the other party.
- *Pick up the handset while the machine is ringing. Follow the same procedure as for manual reception. If you do not pick up the handset, the machine will be changed to automatic reception mode after the specified ringing time. (Refer to the section on the FAX/TEL switch elsewhere in this chapter.)*

Reception by Enhanced Remote Activation

Faxes can be received through the use of an external telephone or an extension telephone.

Remote activation

You can activate the fax machine from a remote telephone. This is useful if you are using the machine on an extension of a key telephone system.

Remote activation allows you to receive a call on a telephone which is either connected from the fax unit, or is parallel connected to your telephone line (extension telephoned), but is not located near the fax unit. If an in-coming call is a fax transmission, simply press F/T & REMOTEID of the external/extension telephone (tone-type) to enable reception of the fax.

Note:

- *If you accidentally pick up your extension or external telephone by mistake when you are transmitting or receiving a FAX. there might be some slight distortion on the document.*
- *If you are using an extension or external telephone, be sure to use "*"and/or"# for the F/T & Remote ID. (This will help you avoid operation errors.)*

Reception into memory (only for FAX-500M)

If the unit has run out of paper it will automatically store any fax transmissions it receives in its memory. Also, if it runs out of paper midway through receiving a transmission, it will store the part of the document that it is unable to print. The following message appears on the LCD display:

CHECK RECORDING PAPER

Load the machine with paper and the unit will print any stored documents or parts of documents.

No data is lost provided you do not turn off the machine prior to printing out the stored documents.

Registering F/T & Remote ID

Use the following procedure to register an F/T & Remote ID.

*The initial setting is " **"*



ABC

2

- 1) Press the FUNCTION key. Then press the 2 key on the number keys.

2.REGISTRATION
PRESS SET KEY



QZ

0

- 2) Press the SET key. Then press the 0 key followed by the 4 key.

04.F/T & REMOTE ID
PRESS SET KEY



GHI

4

- 3) Press the SET key.

F/T & REMOTE ID : **
INPUT / PRESS SET TO END

Enter your chosen F/T & REMOTE ID number. When you have entered it correctly, press the SET key.

- *When you connect the external telephone to a TAD (telephone answering device), the "F/T & REMOTE ID" you enter must be different from the TAD operation ID.*
- *If you are making use of an extension or external telephone, be sure to use the "#" and/or "*" symbols. This will help prevent the fax unit from being turned on (accidentally into reception mode) when you are dialing.*

4. USING ONE-TOUCH NUMBERS

If you regularly send faxes to the same destinations, it is useful to be able to dial these numbers without having to input them in every time using the number keys. A one-touch key enables you to send a fax (or make a telephone call) to a particular destination without having to enter the number every time - you simply press the relevant one-touch key and the machine automatically dials the number you require. The FAX-500M can store up to forty (40) fax or telephone numbers as one-touch numbers. The FAX-410 can store up to twenty (20) fax or telephone numbers as one-touch numbers.

There are twenty one-touch keys, numbered 00 (20) to 19 (39), and a shift key which enables you to store different two destinations numbers under each one-touch key. (This applies only to the FAX-500M.)

(For example, to dial the number stored as one-touch numbered 13, press the one-touch 13 key in the FAX-410/500M. To dial the number stored as one-touch number 39 hold down the SHIFT key and press the one-touch 19 key in the FAX-500M.)

Registering one-touch numbers

To store a fax or telephone number as a one-touch number proceed as follows.



1

- 1) Press the FUNCTION key. Then, press the 1 key on the number keys.

1.ONE-TOUCH / SPEED DIAL
PRESS SET KEY



1

- 2) Press the SET key. Then press the 1 key.

1.ONE-TOUCH DIAL
PRESS SET KEY



- 3) Press the SET key.

ONE-TOUCH DIAL
SELECT ONE-TOUCH KEY

IV-4. USING ONE-TOUCH NUMBERS

ONE TOUCH KEY

- 4) Now press one of the one-touch keys, or hold down the SHIFT key and press a one-touch key. Pressing a key on its own permits you to register one of the numbers 00 to 19. On the FAX-500M, holding down the SHIFT key allows you to register the numbers 20 to 39. The display changes to show the one-touch key number.

*05: _
INPUT / PRESS SET TO END

“*” means one-touch

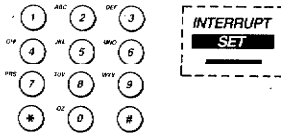

- 5) Enter the number (which can have up to 20 digits). When you have entered the fax or telephone number, press the SET key.

NAME: _
INPUT / PRESS SET TO END

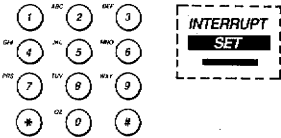

- 6) Enter the name (up to 24 characters on the FAX-500M, up to 19 characters on the FAX-410) in the way described in the section entitled *Entering information using the keys*. Press the SET key when you have finished.

CURRENT : FAX
1.FAX 2.TEL 3.OFF

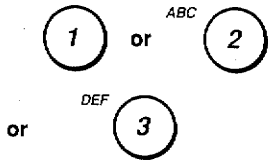

- 7) Press the 1 key for Fax, the 2 key for Telephone, or the 3 key for off. This selection is only used for the dial list. Selecting “off” is used for group keys on the FAX-500M (see page IV-4-3.), or chain dialing keys (see page IV-6-1) on both the FAX-500M and the FAX-410.

CURRENT : FAX
PRESS SET KEY



- 8) Press the SET key to confirm the setting.

ONE-TOUCH DIAL
SELECT ONE-TOUCH KEY

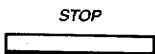

- 9) You can either continue and register another one-touch dial number, or end registration by pressing STOP.

Registering one-touch numbers as a group key (only for FAX-500M)

You can also store many destinations under a single one-touch key as a group. This feature is very useful for the broadcast transmission function (see page V-11-1), sequential polling function (see page V-8-5), and relay broadcasting function. (see page V-12-1)

Defining and storing a group

To define and store a group of destinations use the following procedure.



1) Press the **FUNCTION** key. Then press the 2 key.

2.REGISTRATION
PRESS SET KEY

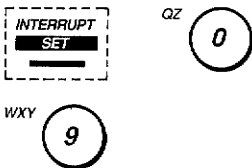

2) Press the **SET** key. Then press the 0 key followed by the 9 key.

09.GROUPING
PRESS SET KEY



3) Press the **SET** key.

GROUPING
SELECT GROUP KEY



4) Press the one-touch key to which you wish to assign the group that you are defining. If you have previously assigned one-touch or group to this key, you are asked whether you want to change or not. (If you have already assigned groups to six one-touch keys the unit will keep and display a message informing you that no new groups can be registered.)

NEW GROUP
ENTER GROUP NO.

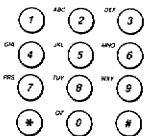

5) You can assign to six groups numbered 1 to 6. Press the group number, using number keys.

GROUP 01
PRESS SET KEY



6) Press the **SET** key.

G01:_
INPUT / PRESS SET TO END

IV. Basic Uses

IV-4. USING ONE-TOUCH NUMBERS

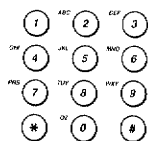

- 7) Enter the members of your new group using already registered speed dial numbers and one-touch keys (you can include up to 139 stations in one group). The name of each destination is shown as you enter it on the lower line. The one-touch or speed dial numbers that you have entered are shown on the upper line.

- A one-touch number will be represented by a " * " in front of the one-touch location number. Speed dialing numbers are represented by a "#" in front of the speed dial location number.

G01:#02#04 *07
FRENCH OFFICES



- 8) Press the SET key to confirm your group selection.

NAME:_
INPUT / PRESS SET TO END

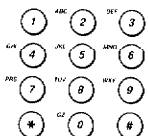

- 9) Enter a name for the new group using the number keys (within 24 characters).

NAME:EUROPEAN OFFICES_
INPUT / PRESS SET TO END



- 10) Press the SET key.

Sending one-touch faxes

To send a fax to a destination whose number is stored under a one-touch key simply follow the steps for sending a fax, either manually or automatically, and instead of dialing the number with the keys just press the relevant one-touch key (or hold down the shift key and press the one-touch key for FAX-500M). The stored fax number is dialed automatically. To begin transmission just press the START key.

Printing a list of one-touch numbers

To print out a directory listing of the names and numbers stored as one-touch dial numbers.



GHI



- 1) Press the FUNCTION key. Then press the 4 key on the number keys.

4.LISTS AND REPORTS
PRESS SET KEY



ABC **2**

2) Press the SET key, then press the 2 key.

2.ONE-TOUCH DIAL
PRESS START KEY

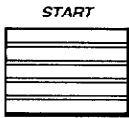

3) Press the START key to print out a list of the one-touch names and numbers. The screen displays a message informing you that it is printing out the list of one-touch dial numbers.

LIST - ONE-TOUCH DIAL
PRINTING



4) Press the CLEAR key to return to the functions menu.

ONE-TOUCH DIAL LIST

TIME : 06/01/1991 18:40
NAME : BROTHER
FAX : 052-811-5981
TEL : 052-824-2554

NUMBER	FAX/TEL NUMBER		DESTINATION	GROUP (only for FAX-500M)
*00	20182858815	FAX	HEAD QTR	
*01	9083568880	FAX	NJ OFFICE	G1 (only for FAX-500M)
*02	31489787788	FAX	FIANCE DEPT	
*03	1467823	FAX	DESIGN DEPT	
*04	71498709892	FAX	LA OFFICE	G1 (only for FAX-500M)
*05	0117361236	TEL	UK OFFICE	G1 (only for FAX-500M)
*06	0899067856	TEL	PARIS OFFICE	G1 (only for FAX-500M)
*07	6753452	TEL	ABC CAMPANY	
.				
.				
.				

IV. Basic Uses

IV-4. USING ONE-TOUCH NUMBERS

Changing or Erasing one-touch names and numbers

You can change or erase one-touch dial names and numbers by following step.



- 1) Select the one-touch dial option from the functions menu and press the relevant one-touch key.

A rectangular screen display showing the text: "*05:BIC US" on the first line and "CHANGE ? 1.YES 2.NO" on the second line.

*05:BIC US
CHANGE ? 1.YES 2.NO



- 2) Press the 1 key. To alter a one-touch dial name and number, enter the new number and name as described in the sections *Entering information using the keys*. To delete a one-touch dial name & number, position the cursor at the extreme left end of the number and press the CLEAR key.

5. USING SPEED DIAL NUMBERS

In addition to one-touch numbers you can also store another hundred on the FAX-500M and forty on the FAX-410 fax or telephone numbers that you can access using two-number combinations - these are known as speed dial numbers. To dial one of these numbers you simply press the SPD. DIAL key followed by the appropriate two-digit speed dial numbers, and the machine dials the number you require. Speed dial numbers are numbered 00 to 99 on the FAX-500, and 00-39 on the FAX-410 (Even if the first digit is 0 you must type it when accessing the number - you cannot just type the SPD. DIAL key + the 1 key to call up the speed dial number 01.)

Registering speed dial numbers

To store a fax number as a speed dial number proceed as follows.



1

1) Press the FUNCTION key. Then press the 1 key.

1. ONE-TOUCH / SPEED DIAL
PRESS SET KEY



ABC
2

2) Press the SET key, then press the 2 key.

2. SPEED DIAL
PRESS SET KEY



3) Press the SET key.

SPEED DIAL
SELECT NO. # _

("#" means "speed")

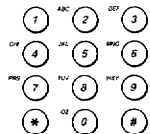

4) Now enter the two-digit speed dial number you want to set.

#10: _
INPUT / PRESS SET TO END

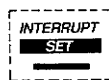
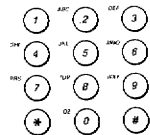

5) Enter number (which can have up to 20 digits).

When you have entered the number, press the SET key.

NAME: _
INPUT / PRESS SET TO END

IV. Basic Uses

IV-5. USING SPEED DIAL NUMBERS

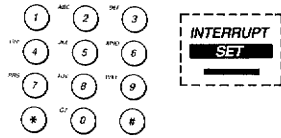

- 6) Enter the name (which can have up to 15 characters on the FAX-500M, and up to 14 characters on the FAX-410) in the way described in the section entitled *Entering information using the keys*. Press the SET key when you have finished.

CURRENT : FAX
1.FAX 2.TEL 3.OFF

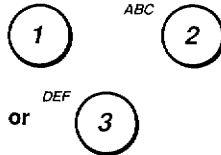

- 7) Press the 1 key for Fax, the 2 key for Telephone, or the 3 key for off. This selection is only used for the dial list. Selecting "off" is used for group keys on the FAX-500M (see page IV-4-3) or chain keys on both the FAX-500M and the FAX-410 (see page IV-6-1), or group keys (see page IV-4-22).

CURRENT : FAX
PRESS SET KEY



- 8) Press the SET key to confirm your choice. The screen again shows:

SPEED DIAL
SELECT NO. #_

STOP

- 9) You can either continue and register another speed dial number, or end registration by pressing the STOP key.

Sending speed dial faxes

To send a fax to a destination whose number is stored under a speed dial key simply follow the steps for sending a fax, either manually or automatically, and instead of dialing the number with the keys just press the SPD. DIAL key followed by the appropriate two digit speed dial code. The stored fax number is dialed automatically. To begin transmission just press the START key.

Printing a list of speed dial numbers

To print out a directory listing of the names and numbers stored as speed dial numbers.



- 1) Press the FUNCTION key. Then press the 4 key.

4.LISTS AND REPORTS
PRESS SET KEY



- 2) Press the SET key, then press the 3 key.

3.SPEED DIAL
PRESS START KEY

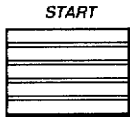

- 3) Press the **START** key to print out a list of the speed dial names and numbers. The screen reverts to the LIST menu.

LIST - SPEED DIAL
PRINTING



- 4) Press the **CLEAR** key to return to the functions menu.

SPEED DIAL LIST

TIME : 06/01/1991 18:40
NAME : BROTHER
FAX : 052-811-5981
TEL : 052-824-2554

NUMBER	FAX/TEL NUMBER		DESTINATION	GROUP <small>(only for FAX-500M)</small>
#00	1-2018285881	FAX	AUSTRALIA OFFICE	G1 <small>(only for FAX-500M)</small>
#01	20135640856	FAX	D.D.LTD.	
#02	001-3-3148978778	FAX	GERMAN OFFICE	G1 <small>(only for FAX-500M)</small>
#03	12358769	TEL	W.CAMPANY	
#04	5892786	TEL	M.CAMPANY	
#05				
#06				

IV. Basic uses

Changing or Erasing speed dial names and numbers

You can change or erase speed dial names and numbers by following these steps.

Select the speed dial option from the functions menu.

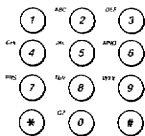

- 1) Press the relevant two digit speed dial code.

#05: BROTHER
CHANGE ? 1.YES 2.NO

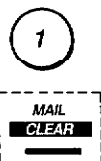

- 2) Press the 1 key. To alter a speed dial name and number, enter the new number and name as described in the sections *Entering information using the keys*. To delete a speed dial name & number, position the cursor at the extreme left end of the number and press the **CLEAR** key.

6. CHAIN DIALING

In addition to the one-touch and speed dialing functions available on the unit, a further convenient option called "chain dialing" can be used with either of the quick dialing functions.

When you send an automatic-transmission, the machine allows you to use a single one-touch dial or speed dial number. However, if you register a one-touch or speed dial as a "chain dialing" number, the machine allows you to use two different one-touch or speed dial numbers (a chain dial number followed by a one-touch, speed dial number or manual dialing (within 20 numbers)).

When dialing overseas fax or telephone numbers, there may be situations in which a company can offer you better rates than the telephone company you normally use. Chain dialing lets you choose the telephone company whose line charge is lower if you register the access code to a second telephone company as a chain dial number. This is also important when using a telephone credit card.

Instructions on how to use this option are provided below.

Setting chain dialing



When you register a one-touch or speed dial number, simply press the CHAIN key before entering the number.

(@mark appears on the screen. @means "chain dialing.")

*05:@
INPUT / PRESS SET TO END

After that, the procedure is the same as for one-touch or speed dial numbers.

- *You can register numbers with up to 19 digits.*
- *You cannot send a transmission using chain dialing only. A one-touch, speed dialing number, or manual dialing (within 20 numbers) number must also be used.*

7. USING THE TELEPHONE INDEX

All the names and numbers that you register as one-touch dial or speed dial numbers are stored in an alphabetical directory list. You can search through this list to find whether a particular person's or company's number is recorded and automatically dial any listed telephone or fax number.

Looking up a number

TEL-INDEX

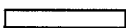

To look up a number in the directory press the TEL-INDEX key. You are prompted to enter the initial letter of the name you are looking up. Use the keys on the number to enter a letter in the same way as entering a name, for example press the 2 key once to enter A, twice for B or three times for C. The LCD screen shows the first name stored under the letter you have entered.

H | HEAD QTR.
PRESS ← → OR STOP KEY

To look through the names stored under the selected letter, use the right cursor key. Each time you press the key the next name in the alphabetical list is shown. To go through the list in the opposite direction (that is, from Z to A) use the left cursor key. To choose a different initial letter use the appropriate letter key.

- *Names are sorted as follows:*

- ① A-Z (alphabet)
- ② Special characters (Ä Ë Ö Ü Æ ø Å Ñ)
- ③ Numbers (0-9)
- ④ Punctuation marks and Symbols

- *If you did not enter a name for one-touch or speed dial number, the fax/telephone number is used as the name, and "number" appears on the LCD.*

Sending a fax

To send an automatic fax to a number recalled from the Telephone Index simply set your document face down in the automatic document feeder, press the TEL-INDEX key, use the appropriate letter key and (← / →) cursor keys, if necessary, to display the name and number you require and then press the START key.

In case of manual transmission, before pressing HOOK key or picking up the handset, you should press TEL-INDEX key and look up the dial, and confirm it by pressing TEL-INDEX key again. After that press HOOK key or pick up the handset, and press TEL-INDEX key again.

Printing out the telephone index

To print out a directory listing of all the names and numbers stored in the telephone index.



GHI



- 1) Press the **FUNCTION** key. Then press the 4 key on the number keys.

4.LISTS AND REPORTS
PRESS SET KEY



GHI



- 2) Press the **SET** key, then press the 4 key.

4.TEL. INDEX
PRESS START KEY



- 3) Press the **START** key to print out the directory.

LIST - TEL. INDEX
PRINTING

TELEPHONE INDEX LIST

TIME : 06/01/1991 18:45
 NAME : BROTHER
 FAX : 052-811-5981
 TEL : 052-824-2554

DESTINATION	NUMBER	FAX/TEL NUMBER	GROUP (only for FAX-500M)
ABC COMPANY	*07	6753452	TEL
ALL OFFICES	*19	*** GROUP 1 ***	
AUSTRALIA OFFICE	#00	1-2018285881	FAX G1 (only for FAX-500M)
DESIGN DEPT	*03	1467823	FAX
D.D.LTD.	#01	20135640856	FAX
FIANCE DEPT	*02	31489787788	FAX
GERMAN OFFICE	#02	001-3-3148978778	FAX G1 (only for FAX-500M)
HEAD QTR	*00	20182858815	FAX
LA OFFICE	*04	71498709892	FAX G1 (only for FAX-500M)
M.COMPANY	#04	5892786	TEL
NJ OFFICE	*01	9083568880	FAX G1 (only for FAX-500M)
PARIS OFFICE	*06	0899067856	TEL G1 (only for FAX-500M)
UK OFFICE	*05	0117361236	TEL G1 (only for FAX-500M)
W.COMPANY	#03	12358769	TEL

C:CHAIN

8. USING THE UNIT AS A TELEPHONE

As well as sending fax transmissions, this fax machine can also be used to make telephone calls. You can either dial numbers manually or use one-touch dialing, speed dialing or the telephone index.

Manual dialing

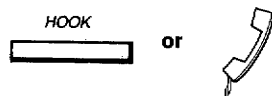

Pick up the handset and dial the telephone number normally using the number keys.

Alternatively, press the HOOK key to enable dialing and then dial the telephone number using the number keys. When the receiving party answers, pick up the handset and proceed with your call.

One-touch dialing

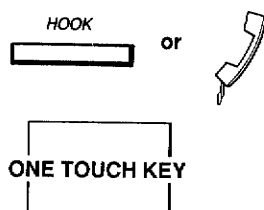

You can use any of the one-touch telephone numbers that you have registered. Simply pick up the handset (or press the HOOK key), and press the appropriate one-touch key. On the FAX-500M you need to hold down the SHIFT key for numbers 20 through 39.

If you use the HOOK key, pick up the handset when your call is answered.

Speed dialing

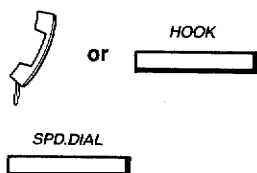

You can also make use of the speed dial feature. Simply pick up the handset (or press the HOOK key), press the SPD. DIAL key and type the appropriate 2 digit speed dial number.

If you used the HOOK key, pick up the handset when your call is answered.

Using the telephone index

To dial a telephone number from the telephone index, first press the TEL-INDEX key and enter the initial letter of the name you are searching for. Use the cursor keys to search forwards and backwards through the directory. When the name you are searching for is displayed on the LCD, press the TEL-INDEX key, pick up the handset (or press the HOOK key) and then press the TEL-INDEX key again. The unit will then dial the displayed number.

If you used the HOOK key, pick up the handset when your call is answered.

Using keys with the telephone

- PAUSE key- Use this key to put a pause between numbers. (You cannot use the PAUSE key continuously.)
- HOLD key- Use this key to put a telephone call on hold.
- Flash key- Use this key to transfer a call and put it on hold.
- # key- Use this key to switch the dialing type to "tone", in case it had previously been set to "pulse".

Using an external telephone

You can use the fax machine with an external telephone or with an external TAD (telephone answering device). Connect the external telephone as described in the "ADDITIONAL SET UP OPTIONS" (see page III-9-1).

Using an external telephone answering device

Connect your external telephone answering device (TAD) to the EXT. DEVICE jack as shown in the illustration below.

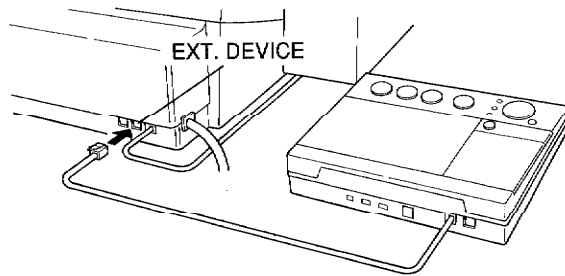

IV. Basic uses

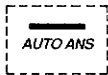

Set the Auto Ans. switch to "Manual" (so that only the "Manual" LED is lit).

The external TAD is now ready for use.

The unit will enter the document reception mode automatically when another party tries to send a fax transmission with a CNG tone to your machine. CNG is generated by most Group 3 FAX machines.

If the sending party (using a tone type unit) presses your F/T & REMOTE ID code, fax reception is switched to the main unit.

- If the ICM section of your external TAD is full, the TAD will not answer the telephone. As a result the unit cannot receive the transmission.
- If your external TAD has a paging function, the unit may prevent the paging function from working.

- Some fax machines may not be able to signal your fax machine to switch on automatically during a transmitting. To cover this possibility we recommend that you record a message on your TAD requesting the sending party to enter the F/T & Remote ID code key on his unit before transmission.

A sample message; "Our answering machine is connected to a fax unit at present, so if you would like to send a fax, please press the XX (your F/T & REMOTE ID) by tone signal and send your fax after you hear the FAX tone. If you would like to leave a message, please do so after this message. Thank you."

V. Advanced uses

1. RESOLUTION

There are four different resolution settings available - STANDARD, FINE, SUPER FINE and PHOTO. The STANDARD resolution is adequate for sending ordinary text documents. FINE resolution is intended for the transmission of graphic images. SUPER FINE is for use with finely-detailed graphic images such as complex line drawings and similar artwork. PHOTO resolution mode is specifically designed for the transmission of photographic images. Whichever mode you use, the quality of the printed document's text will not be adversely affected.

You can select a resolution setting in two ways. Firstly, you can press the RESOLUTION key on the key panel prior to sending your document and light the LED corresponding to the resolution mode you want to select. Your document is then transmitted using the same resolution mode you have selected. Secondly, you can use the CURRENT SETTING function to select a resolution setting for each page of a document individually. Both setting methods will be effective for one transmission only. If the receiving fax machine cannot print at the resolution that you specified, transmission will take place at a lesser resolution. (The resolution LEDs change to show you which resolution is being used to print the current document or page that you are sending is being printed.)

- *"Super Fine" resolution can only be used between Brother machines.*
- *If no LED is lit, the unit is in standard resolution.*

Single resolution transmission

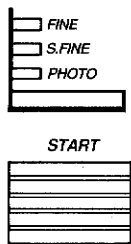

Place your document in the document feeder and dial the number as you do for an ordinary fax transmission. Before pressing the START key select a resolution by pressing the RESOLUTION key. Press once for FINE mode, twice for SUPERFINE and three times for PHOTO mode. Pressing the RESOLUTION key fourth time returns the machine to the standard resolution mode. There are three LED lights positioned next to the RESOLUTION key to indicate the current resolution setting. If all three are not lit, the unit will transmit at the standard resolution. For each of the other three resolution modes, the appropriate light comes on when the mode has been selected.

When you have selected the resolution mode press the START key. Your document will be sent at the specified resolution.

After transmission has been completed the unit reverts to standard resolution mode. The three resolution LEDs are not lit.

FAX : ENTER FAX NO.
 COPY : PRESS COPY KEY

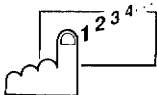

- Any pages for which you did not set a resolution will be transmitted at the same resolution as the last page for which you did set a resolution.

6) Select the fax number in the usual way and press the **START** key. Your document is sent at the specified resolutions.

After transmission has been completed the unit reverts to standard resolution mode. The three resolution LEDs are not lit.

The resolution of in-coming documents

The resolution of fax transmissions that you receive depends entirely on the capabilities of the fax machine from which the document was transmitted and the settings selected by the person sending it. Your fax machine can receive and print documents in three modes, **STANDARD**, **FINE** and **SUPERFINE**. The mode being used to print the document (or the current page) is indicated by the LED lights.

The photo LED is not lit when receiving a document in photo mode.

Copier resolution

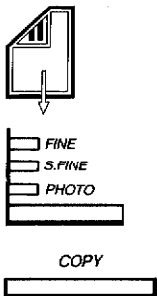

You can use the convenience copier in **SUPERFINE** or **PHOTO** modes. However, you can only use a single mode for each copy operation. Pages of a document that are to be copied at a resolution different to that of the rest of the document must be loaded and copied separately.

Set the document in the feeder. Select a mode by pressing the resolution key, and then press the **COPY** key. If you make a copy without having first selected a resolution, the machine will automatically copy using "SUPER FINE" mode. The **SUPER FINE** LED will come on to show that this mode is being used.

After you have made your copy the unit reverts to the standard resolution mode. The three LEDs are not lit.

V. Advanced uses

2. SETTING THE CONTRAST

The unit has an "Auto-Contrast" feature, so you do not have to select the contrast setting before sending. However, if you want to send a very light document, set the contrast to "SUPER LIGHT" manually.

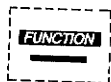

MNO

6

1) To select the "SUPER LIGHT" contrast mode, first set your document in the feeder.

2) Press the FUNCTION key followed by the 6 key. The following message appears.

6.CURRENT SETTINGS
PRESS SET KEY



1

3) Press the SET key followed by the 1 key.

1.CONTRAST
PRESS SET KEY



4) Press the SET key. The current contrast setting is displayed.

CURRENT : AUTO
1.AUTO 2.SUPER LIGHT

ABC

2

5) Press the 2 key to select SUPER LIGHT mode.

CONTRAST : SUPER LIGHT
PRESS SET KEY



STOP



6) Press the SET key to confirm your selection. Then press the STOP key.

7) Now you can send your transmission or make your copy.

- This setting is only effective for one transmission or copy.

3. SMOOTHING (ENHANCED IMAGE RESOLUTION)

The fax machine has the capability to smooth the outlines of text characters on the faxes that you receive. This is a useful feature as it allows you to enhance the presentation quality of text documents that are sent to you without having to rely on the sender to alter the resolution setting on his machine.

There are two possible smoothing settings - ON or OFF. Select OFF to prevent the fax machine from performing any smoothing, and select ON to activate smoothing.

The procedure for turning smoothing ON or OFF is shown below.

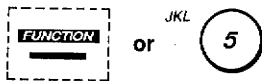

1) Press the FUNCTION key. Press the 5 key on the number keys.

```
5.USER OPTIONS
PRESS SET KEY
```

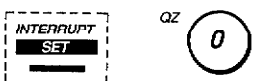

2) Press the SET key. Press the 0 key followed by the 8 key.

```
08.SMOOTHING
PRESS SET KEY
```

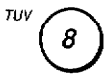

3) Press the SET key.

```
CURRENT : ON
1.ON 2.OFF
```

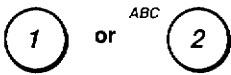

4) Press 1 to select the smoothing mode, and press 2 to turn the smoothing function off.

```
SMOOTHING : OFF
PRESS SET KEY
```



5) Press the SET key to confirm your selection.

The smoothing setting will remain in effect until you change it.

- The initial setting is "ON".

V. Advanced Uses

4. USING THE SUPER COVERPAGE FACILITY

When you send a fax it is often useful to send an accompanying cover sheet at the same time. This sheet is known as the super COVERPAGE and tells the person receiving the fax your name, fax number and telephone number. These are the name and numbers that you will have registered in the machine as part of the configuration process. If you have not registered your name, fax number and telephone number (Station ID), you cannot send the super COVERPAGE.

You can also choose to show on the super COVERPAGE the number of pages you are faxing.

You can include an optional comment on the super COVERPAGE. You can select one of five comments, three that are preset and two original messages which you can create yourself.

Sending a fax with a super COVERPAGE

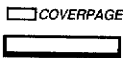

The steps for sending a fax transmission with a super COVERPAGE are as follows.

- 1) Set the document face down in the feeder.

FAX : ENTER FAX NO.
COPY : PRESS COPY KEY

- 2) Press the COVERPAGE key on the panel. The screen prompts you to select one of the five available comments or select to send the fax without a comment. Comments 5 and 6 are the comments that you have registered yourself.

SELECT COMMENT (1-6)
2. PLEASE CALL

The five available comments are ;

1. (comment off)
2. PLEASE CALL
3. URGENT !
4. CONFIDENTIAL
5. (your original comment)
6. (your original comment)

as for 5 and 6, you can register your original comment as described "Entering information using keys".

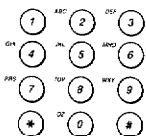

- 3) Make your selection by pressing the appropriate number key from 1 to 6. The screen briefly displays the option you have chosen.

V-4. USING THE SUPER COVERPAGE FACILITY

COVERPAGE
3.URGENT !

- 4) Now the screen displays a message asking you whether you want to show on the super COVERPAGE the number of pages that you are sending.

TOTAL NO. OF PAGES
1.ON 2.OFF

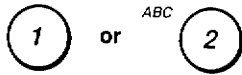

- 5) Press the 1 key if you do, and the 2 key if you do not. If you press 1 you are then prompted to enter the number of pages that you are faxing.

TOTAL PAGES : 00
ENTER TOTAL NO. OF PAGES

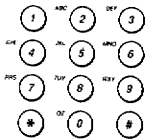

- 6) Enter the number of pages as a two digit number (that is, if you are sending five pages enter "05") using the number keys. The number of pages you enter is briefly shown.

TOTAL PAGES: 05



- 7) The screen display reverts, and the COVERPAGE LED is lit.

ENTER FAX NO.

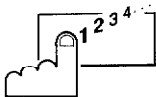

- 8) Now enter the fax number, by using the one-touch key, speed dial manual dial or the Telephone Index, and press the START key.

NJ OFFICE
SENDING COVERPAGE

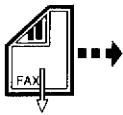

When the super COVERPAGE has been sent, the machine then sends the document.

Printing out a super COVERPAGE

You can print out a sample of the super COVERPAGE as follows.

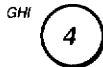

- 1) Press the FUNCTION key, then press the 4 key.

4.LISTS AND REPORTS
PRESS SET KEY

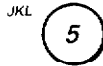

- 2) Press the SET key, then press the 5 key.

5.COVERPAGE
PRESS SET KEY

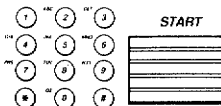

- 3) Press the SET key, then choose the comment you require and press the START key.

V. Advanced Uses

V-4. USING THE SUPER COVERPAGE FACILITY

- The destination of sample super COVERPAGE is taken from one-touch dial number "00".
- If you have nothing programmed in that one-touch, the destination area will be left blank. Also, the total pages will always be "00".

```

==== COVER PAGE ====

TO:      NJ OFFICE
FAX:     908-356-8880

FROM:    BROTHER
FAX:     052-811-5981
TEL:     052-824-2554

COMMENT: 00 PAGE[S] TO FOLLOW
          URGENT !
    
```

Entering a comment

To register your original comment for inclusion on the super COVERPAGE, use the following procedure.

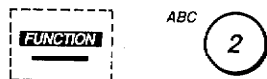

- 1) Press the FUNCTION key followed by the 2 key.

```

2.REGISTRATION
PRESS SET KEY
    
```

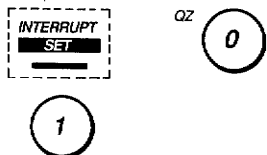

- 2) Press the SET key. Now press the 0 key followed by the 1 key.

```

01.COVERPAGE COMMENT
PRESS SET KEY
    
```

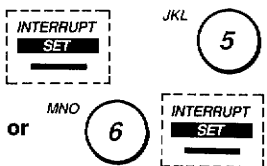

- 3) Press the SET key. Press 5 or 6, depending on which of the two comments you wish to register, then press the SET key again.

```

5._
INPUT / PRESS SET TO END
    
```

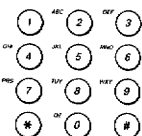

- 4) Enter your comment (which can be up to 27 characters) using the keys on the number keys as described in the section "Entering information using the keys".

```

5.ORDER CONFIRMATION_
INPUT / PRESS SET TO END
    
```



- 5) When you have correctly entered your comment, press the SET key.

5. CALL RESERVATION AND THE CALL BACK MESSAGE

The purpose of this feature is to alert the party receiving your fax transmission that you want to speak to them on completion of the transmission. When your document has been printed at the receiving station the receiving fax machine will ring as if it were receiving a telephone call. If the receiving party is present and picks up the handset your fax machine will also ring. Then you can pick up the handset and talk with the person to whom you have just sent a fax.

Sending a fax with Call Reservation

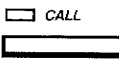

The steps for sending a fax transmission with Call Reservation are as follows:

- 1) Set the document face down in the feeder.

FAX : ENTER FAX NO.
COPY : PRESS COPY KEY

- 2) Press the CALL key.

CALL BACK MSG.
1.ON 2.OFF

The Call Back Message is a text message that will be printed at the receiving station if the receiving party does not answer. The message requests the receiver to call you.

- If you have not registered your telephone number at station ID (see page IV-1-2), you cannot send "Call Back Message".

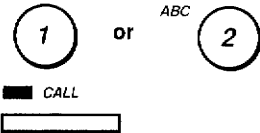

- 3) Press the 1 key if you want a Call Back Message to appear, or the 2 key if you do not. The CALL LED is lit.

ENTER FAX NO.

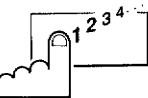

- 4) Select the destination fax number, either by entering it using one-touch dial, speed dial, Telephone Index, or manual dial.

NJ OFFICE
PRESS START KEY

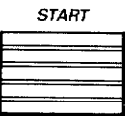

- 5) Press the START key. The machine now transmits automatically.

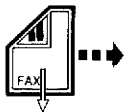

When the document has been transmitted, the unit at the receiving station rings. The message on the screen changes to show:

V. Advanced
uses

V-5. CALL RESERVATION AND THE CALL BACK MESSAGE

NJ OFFICE
CALLING

6) If the receiving party answers, your unit will also ring.

NJ OFFICE
CALL PICKUP



7) You can now pick up the handset and talk.
If the receiving party does not answer and you have previously selected Call Back Message "ON", the Call Back Message will be printed at the receiving station instead.

If an error occurs during the transmission of the fax itself the call reservation function will not operate.

- There are certain types of fax machine which will not respond to the Call Reservation function.
- When auto redialing, Call Reservation will be cancelled. But if you select Call Back Message "on", the unit will send a Call Back Message after sending the document.
- You can print out an example of the Call Back Message
- You cannot use Call Reservation with either the timer, polling, or the broadcast (FAX-500M only) function.
- If you set Call Reservation "on" then set up a Timer (delayed) transmission, the Call Reservation will be cancelled.

Printing out a Call Back message

You can print out a sample Call Back Message as follows.



GHI (4)

1) Press the FUNCTION key, then press the 4 key.

4.LIST AND REPORTS
PRESS SET KEY



MNO (6)

2) Press the SET key. Then press the 6 key for a "Call Back Message".

6.CALL BACK MSG.
PRESS START KEY

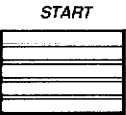

3) Press the START key.

- The destination for the sample Call Back Message is taken from one-touch number "00". If this number is not programmed, the destination area will be blank.

V-5. CALL RESERVATION AND THE CALL BACK MESSAGE

=== CALL BACK MESSAGE ==

TO: NJ OFFICE
FAX: 908-356-8880

FROM: BROTHER

PLEASE CALL AT [TEL] 052-824-2554

[FAX] 052-811-5981

V. Advanced
uses

6. TIMER TRANSMISSION (DELAYED TRANSMISSION)

If you wish to defer the sending of a document (for example, to take advantage of cheaper telephone rates) you can use the Timer delayed transmission facility. Simply place your fax document in the document feeder and set the time at which you want the fax to be sent. The unit will automatically send the fax at the time you have set.

Sending a fax with Timer

The steps involved in sending a delayed fax transmission are as follows:



- 1) Set the document face down in the document feeder.

FAX : ENTER FAX NO.
COPY : PRESS COPY KEY



- 2) Press the **TIMER** key.

TIMER
SET TIMER : 00:00

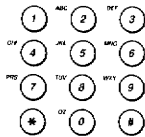

- 3) Use the number keys to enter the time (between 00:00 to 23:59) within the next 24 hours at which you wish to send the fax transmission. When you have entered the 4 digits, the following screen appears after 2 seconds.

23:30
ENTER FAX NO.

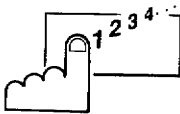

- 4) Now enter the fax number of the destination, using a one-touch key, a speed dial number, a number from the Telephone Index, or dialing manually.

BROTHER
PRESS START KEY



- 5) Now press the **START** key. You can now leave your fax machine as it is and it will send your fax to the specified destination at the appointed time. After transmission has successfully been completed, a "Delayed Sending Report" will be printed out automatically.

- When using the FAX-500M, up to three timer transmission can be preset (for as many as 139 stations.)

V-6. TIMER TRANSMISSION (DELAYED TRANSMISSION)

DELAYED SENDING REPORT	
	TIME : 06/01/1991 14:30
	NAME : BROTHER
	FAX : 052-811-5981
	TEL : 052-824-2554
DATE.TIME	06/01 14:29
FAX NO./NAME	NJ OFFICE
DURATION	00:00:42
PAGE (S)	02
RESULT	OK
MODE	FINE

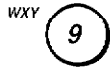

- Your machine can still receive fax transmissions while waiting to send.
 - To cancel timer transmission, press the **FUNCTION** key, the **9** key, and then press the **SET** key to enable the "Cancel Transmission" function.
 - If you want to use the unit for another operation without disturbing your Timer (delayed) transmission settings, press the "Interrupt" key to carry out another operation. (see page V-15-1)
- only for the FAX-500M –**
- If you want to use the unit for another feature without disturbing your Timer (delayed) transmission settings, press the "Memory" key, and store the document into the memory. (This can be done up to 3 times.)

V. Advanced uses

V-6. TIMER TRANSMISSION (DELAYED TRANSMISSION)

Initial Timer

If you want to send a Timer (delayed) transmission every day at a fixed time, you can use the "Initial Timer" function. The time that has been set appears when you press the "Timer" key. (Initial setting is 00:00).

You need only register the initial timer once - you do not need to re-enter the time every day. Then each day just press the **TIMER** key and the **SET** key.

To register the initial time proceed as follows.

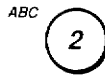

- 1) Press the **FUNCTION** key, then press the 2 key.

```
2.REGISTRATION
PRESS SET KEY
```

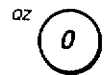

- 2) Press the **SET** key, then press the 0 key followed by the 3 key.

```
03.INITIAL TIMER
PRESS SET KEY
```



- 3) Press the **SET** key.

```
CURRENT : 00:00
CHANGE ? 1.YES 2.NO
```



- 4) Press the 1 key.

```
INITIAL TIMER : 00:00
INPUT / PRESS SET TO END
```



- 5) Enter the time you require and press the **SET** key.

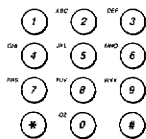

7. THE PASSWORD

The fax password function is provided for use in a closed network of fax machines. It can also be used to help you prevent reception of the "junk faxes" that can interfere with your daily operations. It can also prevent the transmission of faxes to the wrong parties.

Passwords should not be used casually. If you have activated the password function, only people who have Brother (or compatible) fax machines and have set the correct password code on their own machine can exchange faxes with your unit.

To remedy this you can enable the PASSWORD PLUS feature, whereby the unit accepts transmissions without passwords from anybody whose number is listed as a one-touch number. (The unit detects the last four digits of the number whether it is same or not.) People whose numbers have not been registered as a one-touch number in your machine must still use the password.

Sending a fax with password

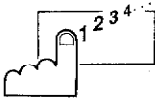
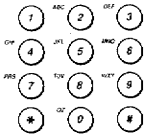

To send a fax with a password, carry out the procedure described below. Before this procedure, please re-check the other party's password code.

- 1) Set the document face down in the feeder.

FAX : ENTER FAX NO.
COPY : PRESS COPY KEY

- 2) Press the PASSWORD key.

PASSWORD : 0000
ENTER CODE NO.

- 3) Enter the 4-digit password code. This must be the same code as the other side's receiving password.

PASSWORD : 1234
ENTER CODE NO.

- 4) When you have entered the 4-digit code, the display will briefly change. (Wait for 2 seconds)

PASSWORD
ENTER FAX NO.

- 5) Enter the fax number using the number keys, a one-touch key, speed dial number, or Telephone Index. Now press START key.

- When the other side sets their receiving password to "off", you can not send a fax with a password, even if the password code is the same as the party's receiving password.
- You cannot use passwords with the following types of transmission.
 - Polling (excluding turn – around polling)
 - Confidential transmission (only for FAX-500M)
 - Relay broadcast request (only for FAX-500M)
 - Remote retrieval of a confidential message (only for FAX-500M)
 - Manual transmission

Setting the fax receiving password

To set the fax receiving password, use the following procedure. Your machine's receiving password is used by the other party when transmitting.



1) Press the FUNCTION key.

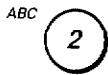

2) Press the 2 key.

2.REGISTRATION
PRESS SET KEY



3) Press the SET key.

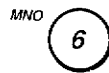

4) Press the 0 key followed by the 6 key.

06.RECEIVE PASSWORD
PRESS SET KEY



5) Press the SET key.

RECEIVE PASSWORD : 0000
INPUT / PRESS SET TO END

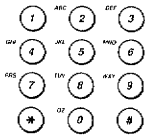

6) Enter a four-digit password number using the number keys.

PASSWORD : 1234
INPUT / PRESS SET TO END

7) Press the SET key to confirm your password setting .

- The initial setting is "0000".
- This procedure merely sets the receiving password. It does not enable password mode. To turn your machine's password "ON" follow the procedure below.

Turning password protection on and off

To turn password protection on or off, or to enable the PASSWORD PLUS function, proceed as follows.



JKL **5**

1) Press the FUNCTION key. Press the 5 key on the number keys.

5.USER OPTIONS
PRESS SET KEY



OZ **0**

2) Press the SET key. Press the 0 key followed by the 7 key.

07.RECEIVE PASSWORD
PRESS SET KEY

PAS **7**

3) Press the SET key.

CURRENT : OFF
1.ON 2.PLUS 3.OFF



1 , **2**
ABC
or **3**
DEF

4) Press the 1 key to turn password protection on, press the 2 key to turn password plus protection on, or press the 3 key to turn password protection off.

RECEIVE PASSWORD : ON
PRESS SET KEY



5) Press the SET key to confirm your selection.

- The initial setting is "off".

V. Advanced Uses

8. POLLING

What is Polling?

Polling is a feature which lets fax machines call other machines to request a fax transmission. The unit can receive a request for transmission of a document (making you the called side) or it can request a document from another unit (which makes you the calling side). The FAX-410 can be used to poll only one unit. The FAX-500M permits you the option of polling one other unit or several different units. It can be operated using either standard or security polling functions.

Polling is among the most advanced features on the machine. While the concept may be new to some users, the operation is always basically the same: one fax machine calls another to request a document. The table below shows the various polling operations which can be carried out by the machine.

- | | |
|--|---|
| • Standard Polling | Sends a request to have a document sent from another fax unit. |
| • Secure Polling | Makes use of a coded security feature when requesting a document. |
| • Timer (delayed) Polling | Sends a request at a specified time for the transmission of a fax from another machine. |
| • Turnaround Polling | Used for "two-way" polling, this lets you send a document, then request a document from another fax unit. |
| • Sequential Polling (only for FAX-500M) | Used to request documents from several different fax units in a single operation. |

Remember that the calling side bears the expense of a fax transmission when polling is done.

STANDARD POLLING

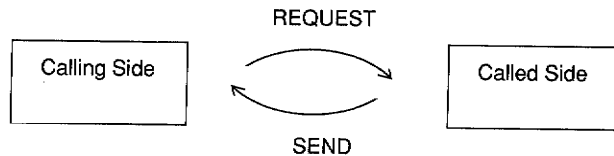

- *There are some types of fax machine which cannot poll or be polled.*
- *Secure polling can only take place between Brother fax machines.*
- *The password function cannot be used with polling, but this function can be used for turn-around polling.*
- *To cancel a polling operation use the 'cancel transmisson' feature.*

Standard polling

To poll for a document that is not confidential (and so is not protected with a secure code) proceed as follows.



- 1) Make sure there is no document in the feeder.

06/01/1991 14:00
FAX/COPY : SET DOC.

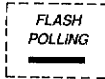

- 2) Press the POLLING key.

SELECT NO.
1. STANDARD 2. SECURE



- 3) Press the 1 key.

POLL
ENTER FAX NO.

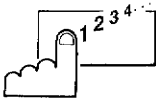

- 4) Enter the fax number of the machine you are polling. You can enter the number using the number keys, one-touch, speed dial or a Telephone Index.

BROTHER MIZUHO
PRESS START KEY

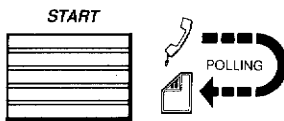

- 5) Press the START key. The machine contacts the called side and requests a document.

- When the called side sets the document with a secure code, you cannot poll the document.

Secure polling

To poll for a confidential document that is protected with a security code, the procedure is as follows.



- 1) Make sure there is no document in the feeder.

06/01/1991 14:00
FAX/COPY : SET DOC.

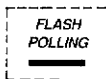

- 2) Press the POLLING key.

SELECT NO.
1. STANDARD 2. SECURE

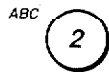

3) Press the 2 key.

POLLING ID : 0000
ENTER CODE NO.

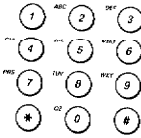

4) Enter the polling ID - this four-digit secure code that should be the same as the secure code used by the called side.

POLLING ID : 4753
ENTER CODE NO.

5) When you have entered the four digit code, the screen will briefly change. (Wait 2 seconds)

POLL
ENTER FAX NO.

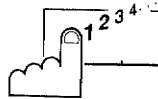

6) Enter the fax number of the machine you are polling. You can enter the number using the number keys or you can use manual dialing, a one-touch, speed dial or Telephone Index.

052824 2864
PRESS START KEY

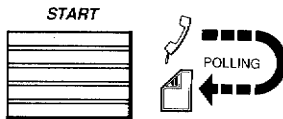

7) Press the START key.

The machine contacts the called side and requests the document.

- When the secure code does not match with that used by the called side, the document cannot be polled.
- The called side's machine should be a Brother machine.

Timer (delayed) polling

Follow the steps described below to set up a timer (delayed) polling operation.



1) Make sure there is no document in the feeder.

06/01/1991 14:00
FAX/COPY : SET DOC.

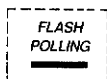

2) Press the POLLING key.

SELECT NO.
1. STANDARD 2. SECURE

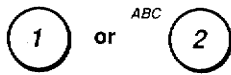

- 3) Press the 1 key if the document for which you are polling is not protected by a secure polling ID code. If it is protected, press the 2 key and enter the polling ID code, as explained in the previous section.

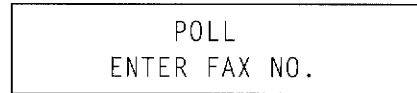

- 4) Press the TIMER key and use the number keys to enter the time at which you want polling to take place.

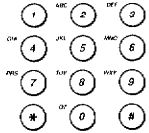
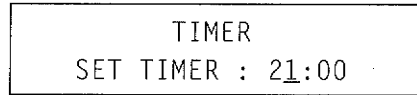

- 5) When you have entered the time (as a 4 digit number), the screen will change briefly.

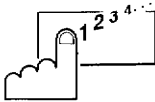
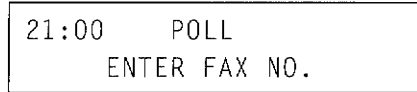

- 6) Enter the fax number of the machine you are polling, either by keying it in using the number keys, a one-touch, speed dial or Telephone Index.

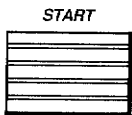
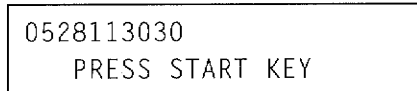

- 7) Press the START key. The initial display is restored and the machine can now be used for other tasks

At the time that you specified, your machine will poll for a document from the station whose number you entered.

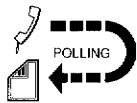

- *Only one delayed polling operation can be preset.*

V. Advanced Uses

Turn-around polling

The following procedure is used to send a fax and poll for a document on the same phone connection.

- 1) Set the document in the feeder.



FAX : ENTER FAX NO.
COPY : PRESS COPY KEY

- 2) Press the POLLING key.



SELECT NO.
1. STANDARD 2. SECURE

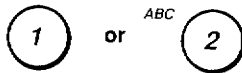

- 3) Press the 1 key if the document for which you are polling is not protected by a secure polling ID code. If it is protected, press the 2 key and enter the polling ID code, as explained in the section *Secure polling*.

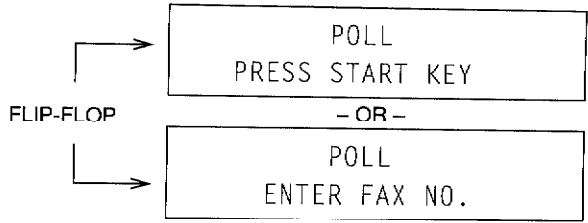

- 4) Enter the fax number of the machine you are polling. You can either key in the number using the number keys, a one-touch, speed dial or Telephone Index.

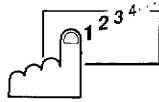

BROTHER MIZUHO
PRESS START KEY

- 5) Press the START key. Your document is transmitted first.

After your document has been transmitted, your machine polls for a document from the called side.

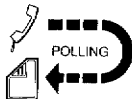
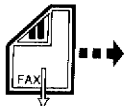

**Sequential Polling
(only for FAX-500M)**

Used to request documents from several different fax units in a single operation.

In the same way that you can send a fax to several destinations in one operation, you can also poll several other stations, requesting fax transmissions. This is known as sequential polling.



- 1) Make sure there is no document in the feeder.

06/01/1991 14:00
FAX/COPY : SET DOC.

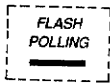

- 2) Press the POLLING key.

SELECT NO.
1. STANDARD 2. SECURE

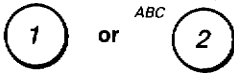

- 3) Press the 1 key if the document for which you are polling is not protected by a secure polling ID code. If it is protected, press the 2 key and enter the polling ID code, as explained in the section *Secure polling*.

POLL
ENTER FAX NO.

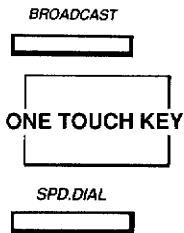

- 4) Press the BROADCAST key and then specify the destination fax machines which you wish to poll using one-touch, speed, or group keys.

*14#25G01
US GROUP



- 5) Press the START key.

Your machine polls each number or group member in turn for a document. After all the polling operations are finished, the "Sequential Polling Report" will be printed out automatically.

SEQUENTIAL POLLING REPORT						
TIME : 06/01/1991 16:21 NAME : BROTHER FAX : 052-811-5981 TEL : 052-824-2554						
DATE	TIME	FAX NO./NAME	DURATION	PAGE (S)	RESULT	COMMENT
06/01	16:18	FIANCE DEPT	20	01	OK	
06/01	16:19	DESIGN DEPT	20	01	OK	
06/01	16:20	LA OFFICE	16	00	ERROR	A0 11
****	****	AUSTRALIA OFFCE	00	00	CANCEL	

Setting a document to be polled.

The steps for setting a document to be polled are shown below.



- 1) Set the document face down in the feeder.

FAX : ENTER FAX NO.
COPY : PRESS COPY KEY



- 2) Press the POLLING key:

SELECT NO.
1. STANDARD 2. SECURE

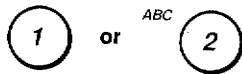

- 3) Press the 1 key to choose standard polling or press the 2 key and enter the 4 digits secure code.

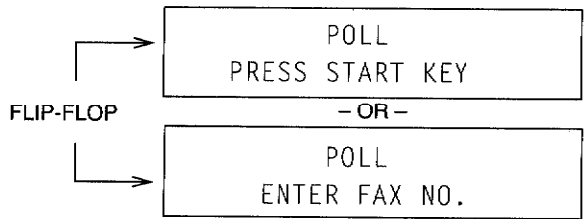

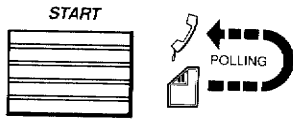

- 4) Press the START key. The machine waits for a call from the calling side.
After a document has been polled, "Polled Report" will be printed out.

POLLED REPORT	
TIME :	06/01/1991 14:23
NAME :	BROTHER
FAX :	052-811-5981
TEL :	052-824-2554
DATE . TIME	06/01 14:22
DURATION	00:00:32
PAGE (S)	01
RESULT	OK
MODE	FINE

- If you select "Secure", the calling side fax machine must be another Brother fax. The calling side must also use the same "secure" code.
- Simply press the MEMORY key (on the FAX-500M) before pressing the START key in order to store a polled document in the machine's memory. Please note that the document will remain in the memory after the calling side has polled for it. This is useful if several stations will poll for same document.
- To delete the document from the memory, press the Function key and then press the 9 key "Cancel Transmission".

9. SENDING FAXES FROM MEMORY (only for FAX-500M)

Sending a fax from memory

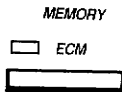

To save time when transmitting a fax you can first store the document in the memory and then transmit it from the machine's memory.

- 1) Set the document face down in the feeder.

FAX : ENTER FAX NO.
COPY : PRESS COPY KEY

- 2) Press the MEMORY/ECM key once. You are prompted to enter the fax number of the destination. The display also informs you what percentage of memory is left for storing your transmission.

If you want to transmit with ECM, press Memory/ECM Key three times. (The ECM LED is lit and the percentage of memory remaining is shown on the LCD.)

ENTER FAX NO. 100%

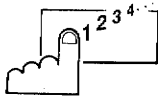

- 3) Enter the destination fax number using the number keys, a one-touch, a speed dial, or a Telephone Index. Press the START key. The document is now scanned into memory.

MEMORY 98%

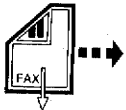

- 4) When all documents have been stored, the unit sends the document from memory automatically.

- You can store up to 14 pages of documents (Brother standard chart) into memory, but this may vary, depending on the contents of the documents.
- When the memory is full, you can select to either send the stored data out of the memory, or to cancel the transmission.
- If the memory becomes full while the first page of a document is being scanned into memory, the message "MEMORY FULL PRESS STOP KEY" appears on the screen. Press STOP key and cancel the transmission.

**Printing out a
"Memory used list"**

To view the 'Memory used' list press the **FUNCTION** key followed by the **4** key on the number keys. Then press the **SET** key. The screen scrolls through the **LIST** menu. Now press the **8** key on the number keys (or the **CLEAR** key if you want to return to the **FUNCTIONS** menu press). Press the **START** key to print out the 'Memory used' list (if you do not press any key for one minute, or if you press the **STOP** key the screen reverts to the normal display). The printout shows details of the following:

Mailboxes

The percentage of memory consumed by the confidential mailboxes and the names of the owners.

Timer

The percentage of memory consumed by any delayed transmission that has been set up, the destination (if it is a broadcast transmission the word "BROADCAST" appears), the time at which it is due to be sent and whether it is to be sent in ECM mode.

Polling

The percentage of memory consumed by any polled operation that has been set up and whether the polling is to use ECM mode.

Redialing

The percentage of memory consumed by the 'last number redial' facility, the number itself and, in the event of redialing, whether the transmission is to use ECM mode.

ECM

The percentage of memory consumed by the ECM function.

Free space

The percentage of memory that is unused.

If you press the **STOP** key while the 'Memory used' list is being printed, the printout is aborted and the screen returns to the normal display.

V-9. SENDING FAXES FROM MEMORY (only for FAX-500M)

MEMORY USED LIST

TIME : 06/01/1991 18:23
NAME : BROTHER
FAX : 052-811-5981
TEL : 052-824-2554

CONF.MAIL BOX	: JOHN SMITH	06%
	: MARY	06%
TIMER	<ECM> : 18:00 HEAD QTR	04%
	: 13:15 0528242864	04%
	<ECM> : 23:45 <BROADCAST>	04%
POLLING WAITING	<ECM>	04%
REDIAL WAITING	: UK OFFICE	06%
ECM		24%
FREE		42%

10. SENDING FAXES WITH THE ECM FEATURE (only for FAX-500M)

Error correction mode (ECM) is a means for checking the integrity of a fax transmission while it is in progress. ECM transmissions are only possible between two machines which both have the ECM feature. Also, the feature requires a certain amount of memory in order to function.

To send a document in ECM mode set the document in the paper feed.

FAX : ENTER FAX NO.
COPY : PRESS COPY KEY

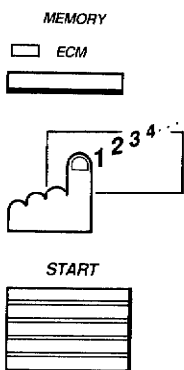

Press the MEMORY/ECM key to light the ECM LED and dial the number of the destination. You can dial using the number keys or use one-touch dialing, speed dialing or the Telephone Index.

Finally, press the START key to send the fax. As the document is sent, the transmitting and receiving machines will constantly check the transmission. If an error occurs, the erroneous part of the transmission is automatically ignored and the relevant data retransmitted. The ECM LED remains on during transmission to indicate that the fax is being sent in ECM mode.

If there is not enough machine memory available for ECM to work properly, or if the receiving fax machine does not have the ECM feature, the document is sent normally, that is, without any error correction. In these two cases the ECM LED does not remain on during the transmission - this indicates that the fax is not being transmitted in ECM mode.

- *Since the units are constantly checking the data and may have to retransmit some of the lines, there maybe a slight increase in transmission time.*

11. BROADCASTING

(only for FAX-500M)

A broadcast transmission is a transmission that you send to several different destinations with a single operation. You simply set your document face down in the document feeder, press the BROADCAST key, specify the destinations and then send the fax just like any normal transmission.

Sending a broadcast fax



- 1) Set the document face down in the feeder.

FAX : ENTER FAX NO.
COPY : PRESS COPY KEY

BROADCAST



- 2) Press the BROADCAST key.

BROADCAST
ENTER FAX NO. 100%

ONE TOUCH KEY



- 3) Now specify the destinations, to a maximum of 20 destinations, that you wish to broadcast to using group keys, one-touch keys, or speed dial keys. (You cannot dial numbers using the number keys or the Telephone Index).

The name of each destination or group appears on the lower line of the screen as you enter it. The one-touch numbers, speed dial numbers or group numbers that you have selected appear on the upper line.

*01#10G03
DUTCH OFFICES

SPD.DIAL



- 4) When you have finished entering the destinations press the START key. The fax is scanned into the machine's memory automatically and then transmitted to each destination in turn.

MEMORY 100%

START

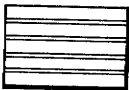

- Transmission is not possible if the memory is nearly full.
- It is convenient to register stations to which you frequently send broadcast faxes as a group. (See Defining and storing a group).

V-11. BROADCASTING (only for FAX-500M)

- You can specify up to 20 numbers as destinations for a single broadcast fax. A group counts as a single destination. Including all group members, you can transmit a broadcast fax to up to 139 stations at once.
- After the broadcast key has been pressed, the only operation which can be performed is setting the fax number.

After finished all transmission, a "Broadcast Report" will be printed out automatically.

BROADCAST REPORT									
TIME : 06/01/1991 15:16 NAME : BROTHER FAX : 052-811-5981 TEL : 052-824-2554									
<table border="1" style="width: 100%; border-collapse: collapse;"> <tr> <td style="width: 50%;">PAGE (S)</td> <td style="width: 20%;">01</td> <td style="width: 30%;">COVERPAGE</td> </tr> </table>							PAGE (S)	01	COVERPAGE
PAGE (S)	01	COVERPAGE							
DATE	TIME	FAX NO./NAME	DURATION	PAGE(S)	RESULT	COMMENT			
06/01	15:12	FIANCE DEPT	45	01 CV	OK				
06/01	15:13	DESIGN DEPT	45	01 CV	OK				
06/01	15:15	LA OFFICE	51	00 CV	ERROR	20 01			
06/01	15:16	AUSTRALIA OFFCE	06	00	CANCEL				
CV : COVERPAGE CA : CALL BACK MSG POL : POLLING RET : RETRIEVAL									

V. Advanced Uses

12. RELAY BROADCASTING (only for FAX-500M)

You can send a broadcast fax transmission via another Brother fax machine. The purpose of this feature is to enable you to reduce costs by faxing several distant stations via a single station which is closer to the destinations. This is particularly useful for broadcasting overseas.

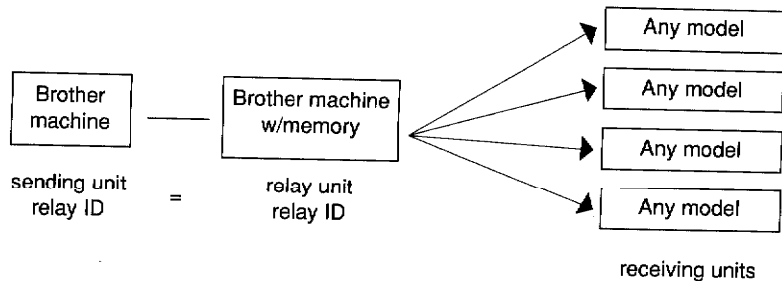

Relay broadcasting is available under the following conditions:

- The same relay ID must be used by both the sending unit and relay unit.
- The destination group on your machine and that used by the relay unit must be identical (that is, have the same members). Otherwise the relay unit may send the document to a station for which the document was not intended.
- The memory in the relay unit must not become full during the transmission operation.

Sending a relay broadcast request



TUV



To send a relay broadcast fax the procedure is as follows.

- 1) Set your document face down in the document feeder.

FAX : ENTER FAX NO.
COPY : PRESS COPY KEY

- 2) Press the FUNCTION key followed by the 8 key.

8.RELAY BROADCAST
PRESS SET KEY



3) Press the SET key.

RELAY ID : XXXX
ENTER CODE NO.

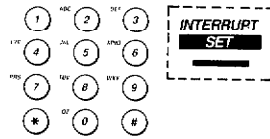

4) Enter a four-digit ID number, then press the SET key.

RELAY BROADCAST
ENTER GROUP NO.

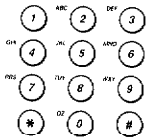

5) Now enter the number of the group which you want the relay terminal to broadcast to. You must enter the group as a two-digit number using the number keys. (Do not use the group's one-touch dial key.)

GROUP 01
PRESS SET KEY



6) When you have entered the group number correctly, press the SET key.

RELAY BROADCAST
ENTER FAX NO.

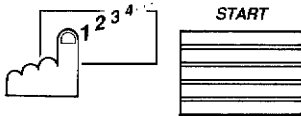

7) Now enter the fax number of the relay terminal. You can either enter the number manually from the number keys or use a one-touch, speed dial or Telephone Index. Then press the START key.

Using Your Machine as the Relay Unit

Your machine can be used as a relay unit for sending broadcast transmissions to several other destinations. As this is an automatic operation, simply leave your machine in the Auto Ans. mode, and the unit will dial and send the fax to the numbers included in the group specified at the point of origin.

When your machine is used as the relay unit during relay broadcasting, a Relay Broadcast Report will appear at your unit (not at the original sending unit, which receives an activity report) to show the results of the relay transmissions after all transmission attempts have been completed.

Registration of relay ID.

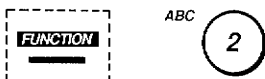

1) Press the FUNCTION key. Then press the 2 key.

2. REGISTRATION
PRESS SET KEY

V. Advanced Uses

V-12. RELAY BROADCASTING (only for FAX-500M)



0Z (0)

2) Press the SET key. Then press the 0 key followed by the 7 key.

PRS (7)

07.RELAY ID
PRESS SET KEY



3) Press the SET key.

RELAY ID : 0000
INPUT / PRESS SET TO END

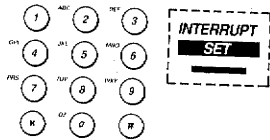

4) Enter the relay ID using the number keys. When you have entered it correctly, press the SET key.

After the Relay Broadcast operation is finished, a "Relay Broadcast Report" will be printed out automatically at the relay unit.

RELAY BROADCAST REPORT

TIME : 06/01/1991 16:03
 NAME : BROTHER
 FAX : 052-811-5981
 TEL : 052-824-2554

*** RECEIVE DATA ***

DATE.TIME	06/01 15:59
FAX NO./NAME	0528242864
DURATION	00:00:18
PAGE(S)	01

DATE	TIME	FAX NO./NAME	DURATION	PAGE(S)	RESULT	COMMENT
06/01	16:00	FINANCE DEPT	15	01	OK	
06/01	16:01	DESIGN DEPT	15	01	OK	
06/01	16:02	LA OFFICE	25	00	ERROR	20 01
****	****	AUSTRALIA OFFICE	00	00	CANCEL	

13. CONFIDENTIAL MAILBOXES (only for FAX-500M)

You can allocate three confidential mailboxes to individuals or groups of individuals, so that each individual or group can receive private messages. These are not printed out when they are received but are stored in the memory. Only the person or people who know the mailbox retrieval ID number can print out these transmissions. A single mailbox can store several transmissions. Messages remain in the mailbox until you print them out or until the machine is turned off. Both fax units must be Brother machines.

Registering a confidential mailbox

A mailbox must have assigned to it a confidential identification ID number, a retrieval ID and a name. To transmit to a mailbox the person sending the transmission must quote the confidential ID number. To retrieve a document from his mailbox the owner must enter the retrieval ID. The name is used for the "Confidential Message Information" which informs the owner that a confidential message is waiting for him.

To set up a confidential mailbox the procedure is as follows.

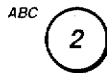

- 1) Press the FUNCTION key. Press the 2 key.

2. REGISTRATION
PRESS SET KEY



- 2) Press the SET key.

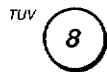

- 3) Press the 0 key followed by the 8 key.

08. CONFIDENTIAL
PRESS SET KEY



- 4) Press the SET key.

MAIL BOX NO.
SELECT NO. (1-3)



- 5) Select the number of the mailbox (1 - 3) that you want to set up.

MAIL BOX NO.1
PRESS SET KEY

V. Advanced uses

V-13. CONFIDENTIAL MAILBOXES (only for FAX-500M)



6) Press the SET key.

RETRIEVAL ID : XXXX
INPUT / PRESS SET TO END

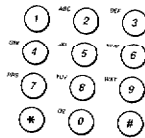

7) Enter a four-digit retrieval ID number using the number keys.

RETRIEVAL ID : 4572
INPUT / PRESS SET TO END

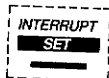

8) Press the SET key to confirm your setting.

CONF. ID : 0000
INPUT / PRESS SET TO END

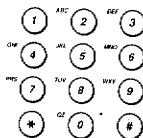

9) Now enter a four-digit confidential mailbox ID number using the number keys.

CONF. ID : 8423
INPUT / PRESS SET TO END



10) Press the SET key to confirm your setting.

NAME : _
INPUT / PRESS SET TO END

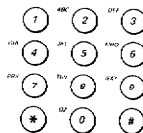

11) Enter the name you wish to assign to your mailbox using the number keys. The name can be up to twenty characters long. Press the SET key to confirm your setting.



- If the memory is full, it cannot receive confidential messages.
- When you are setting up the confidential mailbox, be sure to write the name and ID down, and keep the information somewhere safe.
- You must enter different codes for each of the three mail boxes. If a code number has already been used for another mail box ID, the machine will reject the code number and you must use another one.

Changing the mail box ID

If you want to change the mailbox name or ID, carry out the following procedure.



1) Press the **FUNCTION** key. Then press the **2** key.

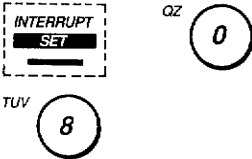

2) Press the **SET** key. Then press the **0** key followed by the **8** key.

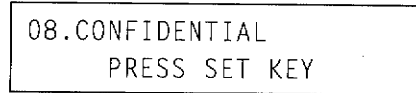

3) Press the **SET** key.

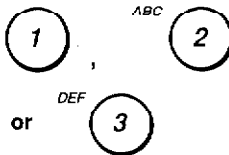
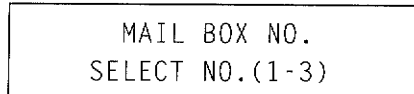

4) Enter the mail box number which you want to change.

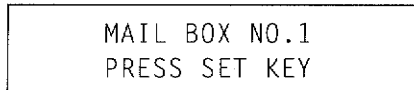

5) Press the **SET** key.

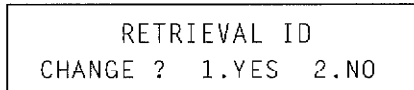

6) Press the **1** key to change.

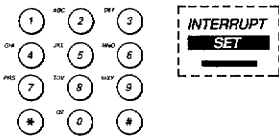
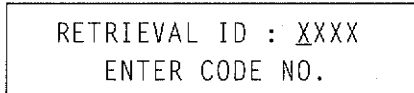

7) Enter the retrieval ID of the mail box which is to be registered then press **SET** Key. (This is to prevent interference with the mailbox by other people.)

8) When you have entered the correct ID number, you can change the name or ID. If the correct ID cannot be entered, it cannot be changed.

Printing out confidential information

To check whether the machine has received a confidential message or not, you can print out a report on Confidential Message Information currently stored in the unit.

V. Advanced uses

V-13. CONFIDENTIAL MAILBOXES (only for FAX-500M)



1) Make sure there is no document in the feeder.

2) Press MAIL key.

CONF. MESSAGE INFO.
PRESS START KEY

3) Press START key.

If you are the owner of a mail box and there is a message in it for you, the unit will print out a sheet alerting you that a message has been received.

CONFIDENTIAL MESSAGE INFORMATION

TIME : 06/01/1991 18:34
NAME : BROTHER
FAX : 052-811-5981
TEL : 052-824-2554

* PLEASE PASS THIS MESSAGE TO FOLLOWING PERSON

TO: JOHN SMITH
A CONFIDENTIAL MESSAGE HAS BEEN RECEIVED FOR YOU.
PLEASE PRINT IT OUT FROM MEMORY. THANK YOU.

You can also get this information from a "Memory Status Report" (see page V-5-23).

Printing out a confidential message



1) To retrieve your message, press the FUNCTION key followed by the 7 key.

7. CONFIDENTIAL MAIL BOX
PRESS SET KEY



2) Press the SET key.

ABC
2

3) Press the 2 key.

2.CONF.PRINT OUT
PRESS SET KEY

INTERRUPT
SET

4) Press the SET key.

RETRIEVAL ID : XXXX
ENTER CODE NO.

1	MFC	2	MFC	3
4	JNI	5	MFC	6
7	TUV	8	WXY	9
*	0			#

5) Enter the retrieval ID code for your mailbox.

RETRIEVAL ID : 6349
PRESS SET KEY

INTERRUPT
SET

6) When you have entered the number press the SET key. The confidential message is printed out for you.



CONF. MESSAGE
PRINTING

After printing the FAX-500M screen reverts to displaying the normal message.

- If you specify an incorrect retrieval ID, the confidential message will not be printed out. Also, after three attempts to make an entry have failed, the screen will return to the Function menu.
- Messages remain in a mailbox until printed out or until the machine is turned off.

V. Advanced
uses

Transmitting to a mailbox

 
PRS 7

1) Set the document face down in the feeder, and press the FUNCTION key. Press the 7 key.

7.CONFIDENTIAL MAIL BOX
PRESS SET KEY

INTERRUPT
SET

2) Press the SET key.

1

3) Press the 1 key.

1.CONF. TRANSMIT
PRESS SET KEY

V-13. CONFIDENTIAL MAILBOXES (only for FAX-500M)



4) Press the SET key.

CONF. ID : XXXX
ENTER CODE NO.

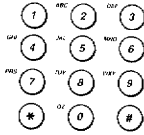

5) Enter the ID code for the mailbox on the destination machine to which you want to transmit your document.

CONF. ID : 6535
PRESS SET KEY

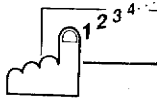

6) When you have entered the number press the SET key. Enter the fax number of the destination to which you are sending and press START.

- If the confidential mail box ID does not match the confidential ID of the party to whom you wish to transmit, you can not send a confidential message.

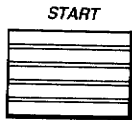

Retrieving confidential messages

If you are the owner of a mailbox on an FAX-500M but you are away from the machine at a different office, you can still retrieve messages from your mailbox and print them out using another FAX-500M (or certain other models of Brother fax machine).

Use the following procedure to remotely retrieve a confidential message using a FAX-500M.



1) Press the FUNCTION key followed by the 7 key.

7. CONFIDENTIAL MAIL BOX
PRESS SET KEY



2) Press the SET key.



3) Press the 3 key.

3. REMOTE RETRIEVAL
PRESS SET KEY



4) Press the SET key.

RETRIEVAL ID : XXXX
ENTER CODE NO.

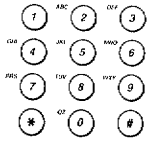

5) Enter the retrieval ID code for your mailbox.

RETRIEVAL ID : 6349
PRESS SET KEY

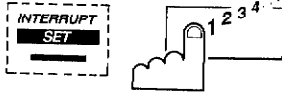

6) When you have entered the number correctly press the SET key. Now dial the fax number of your own machine, the one on which your mailbox resides, and press the START key.

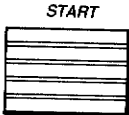

The transmission that was waiting for you in your mailbox will now be printed out for you, at the station where you are now.

A retrieval report will be printed out at the machine on which your mailbox resides.

RETRIEVAL REPORT

TIME : 06/01/1991 13:44
NAME : BROTHER
FAX : 052-811-5981
TEL : 052-824-2554

DATE.TIME	06/01 13:42
DURATION	00:01:58
PAGE (S)	05
RESULT	ERROR
ERROR CODE	20 01
MODE	FINE

V. Advanced
uses

14. VARIOUS TYPES OF TRANSMISSION

As described in "Advanced Uses", this unit has many useful dedicated keys. And you can do various types of transmissions can be carried out by pressing these keys in combination.

A Summary of "Advanced uses" is provided bellow.

1. The following dedicated keys are available for all transmissions.



2. The following key is not available for delayed and broadcasting transmission operation.



3. The following key is not available for polling with no document and retrieval. (only for FAX-500M)



4. The following keys are available for the various types of transmissions listed below.

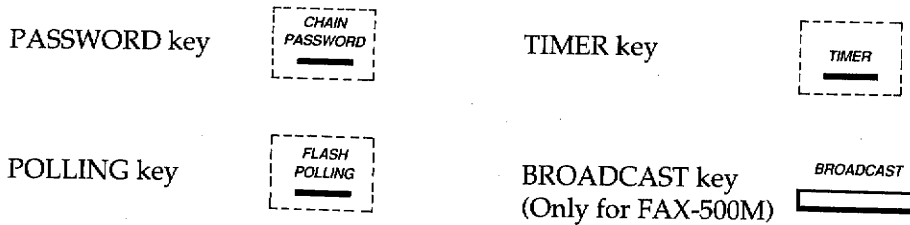

- (1) Timer (delayed) transmission with password

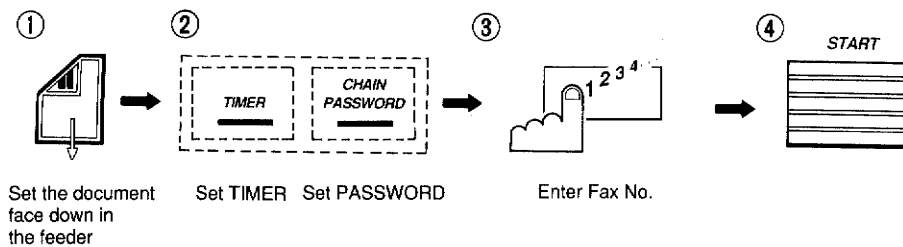

(2) Timer (delayed) polling

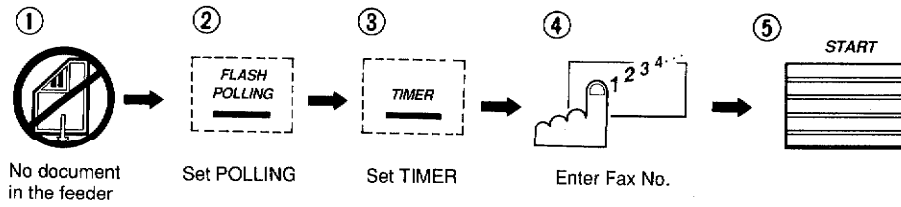

(3) Turn around polling with password

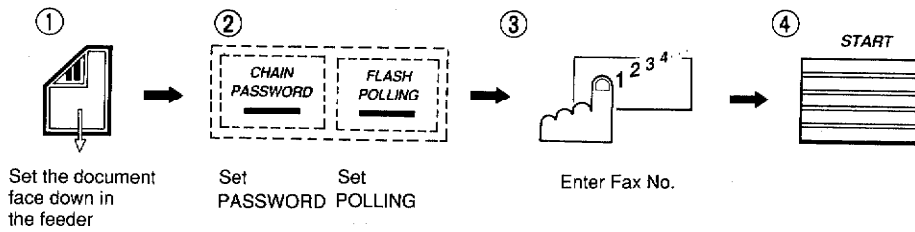

(4) Timer (delayed) turn around polling with password

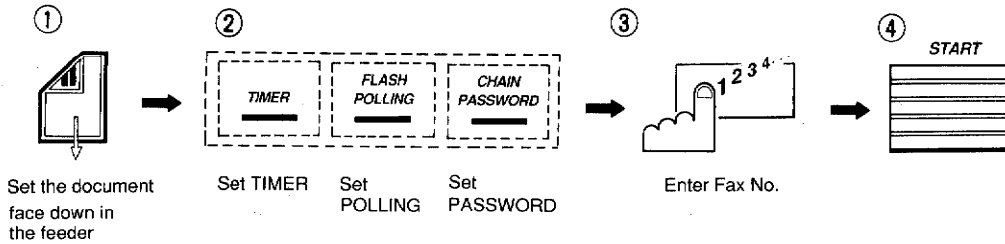

(5) Timer (delayed) broadcasting transmission (only for FAX-500M)

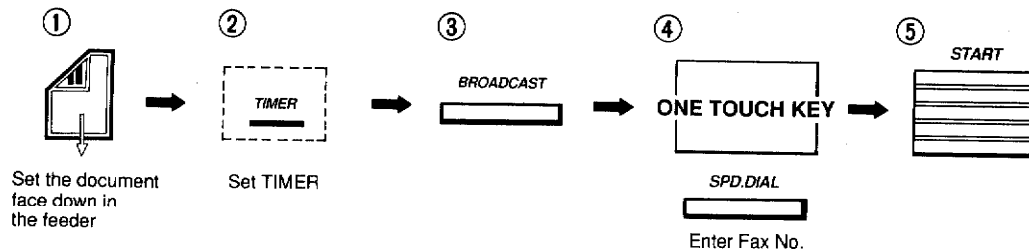

V. Advanced uses

V-14. VARIOUS TYPES OF TRANSMISSION

(6) Sequential polling (only for FAX-500M)

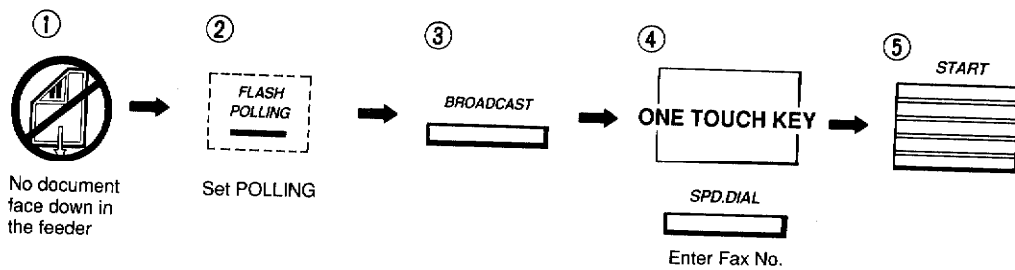

(7) Broadcasting transmission with password (only for FAX-500M)

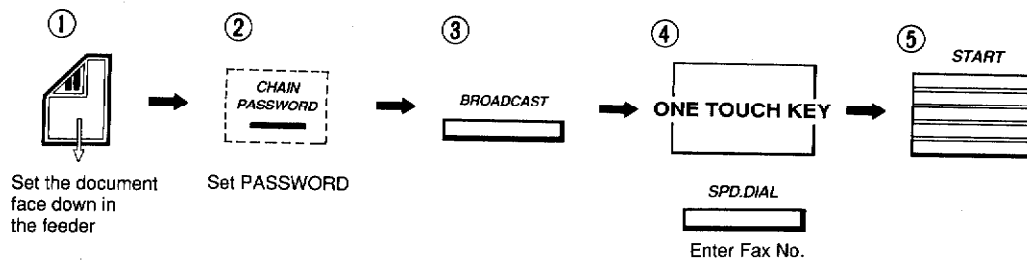

(8) Timer (delayed) broadcasting transmission with password (only for FAX-500M)

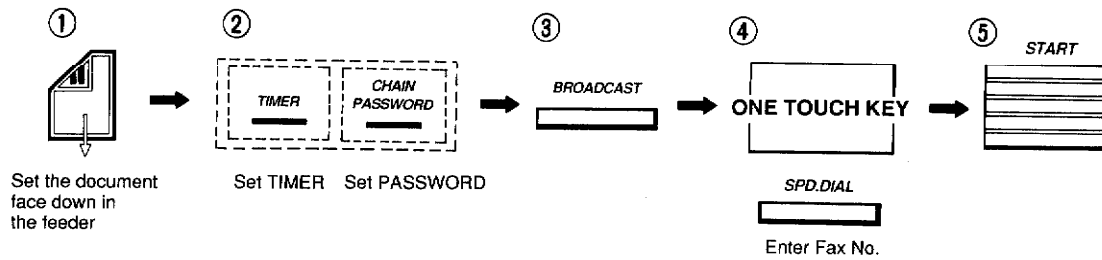

(9) Timer (delayed) sequential polling (only for FAX-500M)

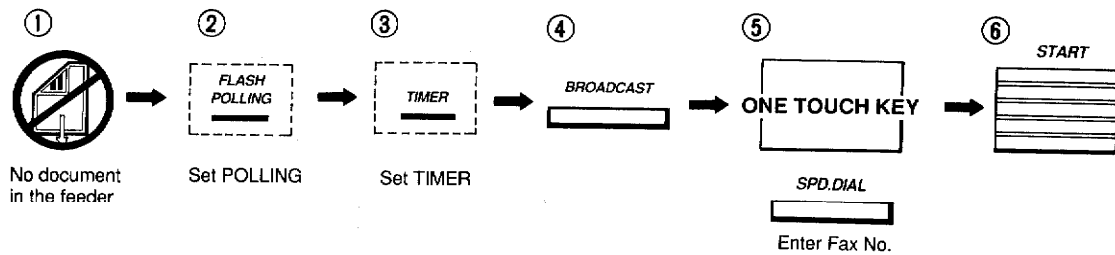

15. INTERRUPTING A TRANSMISSION

If you need to send a document immediately but the machine is set up to perform an operation, (for example a delayed transmission or waiting polled operation without memory). You can interrupt the current activity and then resume it when you have sent your urgent fax.



1) Press the INTERRUPT key.

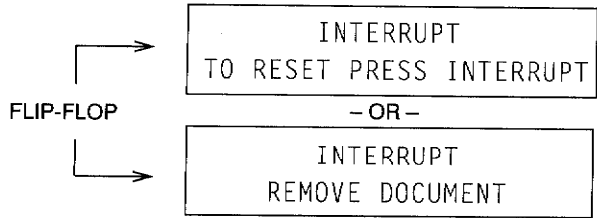

2) Remove the document.



3) Set the document that you need to send quickly face down in the feeder.

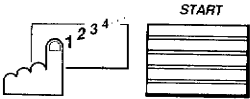
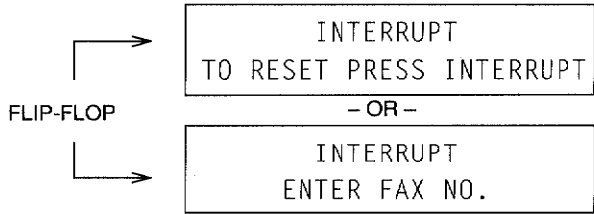

4) Enter a fax number. Then press the START key. The machine will send the document.

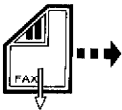

5) When transmission has been completed the following message is displayed.

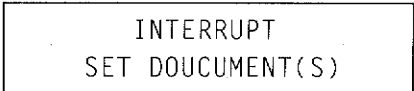

6) Replace the original document.

V. Advanced uses

V-15. INTERRUPTING A TRANSMISSION

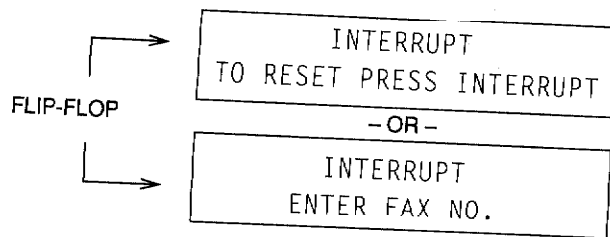

7) Press the INTERRUPT key again. The machine returns to the waiting mode.

- You can repeat the interrupt operation as often as you like.
- You can use the resolution setting and super COVERPAGE. Other current settings can not be used for the interrupt transmission.
- Even if auto redial is "ON", it cannot be used for an interrupt transmission.

16. CANCELLING A TRANSMISSION

You may wish to cancel a particular activity that is in progress or that is due to take place at a specified time. An example of this would be a delayed transmission operation.



WXY **9**

1) To do this press the **FUNCTION** key. Press the **9** key on the number keys.

9.CANCEL TRANSMISSION
PRESS SET KEY



2) Press the **SET** key. The screen now displays the various transmission activities that are currently in progress or will take place in the future.

FLIP-FLOP

SELECT NO.
1.HEAD OFFICE 21:00
- OR -
SELECT NO.
2.341 1411 REDIAL

3) Select number of operation that you wish to cancel.

HEAD OFFICE 21:00
CANCEL ? 1.YES 2.NO

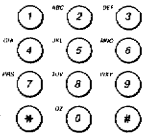

1 or ^{ABC} **2**

4) Enter the **1** key to confirm cancellation or the **2** key to reinstate the transmission activity.

The meaning of the different LCD indications is as follows.

HEAD OFFICE 21:00
Destination setting

Destination NameMeans Destination Name
NumberMeans Destination Number
Broadcast ..Means broadcast transmission (only for FAX-500M)

V. Advanced uses

V-16. CANCELLING A TRANSMISSION

Setting 00:00 Means "Timer" transmission time. If using the "Timer", the current setting will appear "00:00 (setting time)"
POLL Means "Polling" not "Timer".
RET Means "Retrieval" (only for FAX-500M)
REDIAL Means "Redial" without "Timer", "Polling" or "Retrieval". (only for FAX-500M)
POLLED Means "Polled"

If the broadcast transmission is cancelled, a "broadcasting report" will be printed out. (only for FAX-500M)

17. OPTIONAL KITS

You can expand further your fax machine with the following optional kits.

- **Expandable Memory.** (only for the FAX-500M)
You can expand the machine's memory up to 512KB or 768KB.
- **Transmission document tray**
An additional tray is available for catching the transmitted documents.

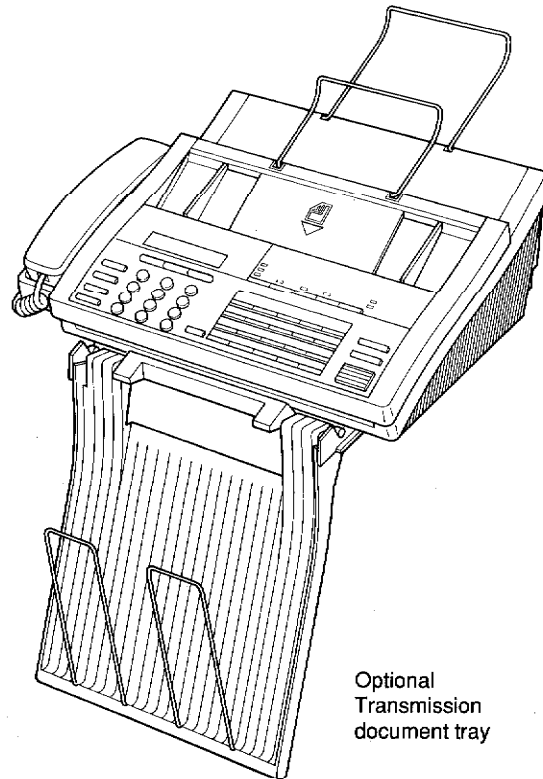

Optional
Transmission
document tray

V. Advanced
uses

For detailed information, please contact your dealer or the shop where you bought this machine.

18. PRINTING OUT REPORTS AND LISTS

The unit allows you to print out the following lists and reports.

- All dial lists (Print out one-touch dial and speed dial at once.)
- One-touch dial list (see IV-4-4)
- Speed dial list (see IV-5-2)
- Telephone Index list (see IV-7-2)
- Super COVERPAGE format (see V-4-2)
- Call Back Message format (see V-5-2)
- System Configuration list (see V-18-2)
- Memory used list for the FAX-500M (see V-9-2)
- Transmission verification report (see IV-1-12)

Other reports

The following reports are printed out automatically for your information. (You cannot print them out manually.)

- Transmission Verification Report (ERROR) (see IV-2-1)
- Power failure report (only for FAX-500M) (see V-18-4)
- Polled report (see V-8-7)
- Broadcast report for the FAX-500M (see V-11-2)
- Delayed sending report (see V-6-2)
- Relay broadcast report for the FAX-500M (see V-12-3)
- Sequential polling report for the FAX-500M (see V-8-6)
- Retrieval report for the FAX-500M (see V-13-7)

All-dial list

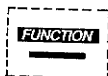

GHI **4**



1



An all-dial list is a printout both of "one-touch dial list" and "speed dial list" at once.

1) Press the **FUNCTION** key. Then press the **4** key.

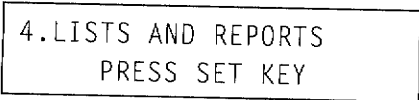

2) Press the **SET** key and then the **1** key.



3) Press the **START** key. Both one-touch dial list and speed dial list are printed out.

Configuration list

A configuration list is a printout showing all the user switch settings and registration into the machine.



GHI 

- 1) To print out a configuration list press the **FUNCTION** key. Press the 4 key.

4.LISTS AND REPORTS
PRESS SET KEY



PAS 

- 2) Press the **SET** key followed by the 7 key.

7.USER OPTIONS
PRESS START KEY



- 3) Press the **START** key.

(See next page for the sample of this list)

V-18. PRINTING OUT REPORTS AND LISTS

SYSTEM CONFIGURATION LIST

TIME : 06/01/1991 18:11
NAME : BROTHER
FAX : 052-811-5981
TEL : 052-824-2554

USER OPTIONS

1.	RING DELAY	: SHORTER ✓
2.	TONE/PULSE	: TONE
3.	AUTO REDIAL	: ON
4.	XMT VERIFICATION (OK) REPORT	: ON ✓
5.	FAX/TEL RING TIME	: 10 SECS. ✓
6.	BEEPER	: ON
7.	RECEIVE PASSWORD	: OFF
8.	SMOOTHING	: OFF ✓

PARAMETER

1.	COVER PAGE COMMENT	
	5	: ORDER COFIRMATION
	6	: NOT USED
2.	INITIAL TIME	: 19:00
3.	FAX/TEL SWITCH ID	
	FAX REMOTE ACTIVATION ID	: *#
4.	RTI/TTI	
	NAME	: BROTHER
	FAX	: 052-811-5981
	TEL	: 052-824-2554
5.	RECEIVE PASSWORD	: 1234
6.	RELAY ID	: 3456 (only for FAX-500M)
7.	CONFIDENTIAL MAIL ID	: (only for FAX-500M)
	BOX 1	: JOHN SMITH
	BOX 2	: MARY
	BOX 3	: NOT USED
8.	NOT USED	

**Power Failure Report
(only for FAX-500M)**

If the power failure has occurred, or you unplug the unit, a "Power Failure Report" will be printed out automatically, and you will know what memory has been lost.

POWER FAILURE REPORT

TIME : 06/01/1991 11:10
NAME : BROTHER
FAX : 052-811-5981
TEL : 052-824-2554

THE ELECTRICITY FAILED.
THE FOLLOWING DATA WAS LOST

TRANSMISSION MEMORY
RECEPTION MEMORY

VI. Troubleshooting

This section provides possible solutions to the problems you may encounter in the use of this machine.

-If There Are Image Quality Problems-

If you are having trouble with the image quality of faxes you send or receive, make a test copy of the document. If the copy is of good quality, the problem is not with your fax machine, but in the phone lines or in the fax machine on the other end of the line.

If the image of the copy you make is poor, clean the interior of the unit. (See page VII-2 for a description of how to do this.)

If you are not able to solve a problem with your fax machine, contact Brother service personnel at 1-800-284-4FAX. (U.S.A. Only).

RECEIVING

SYMPTOM	POSSIBLE CAUSE	ACTION	cf.
Manual reception doesn't work	<ul style="list-style-type: none"> • Document left in feeder • Cover not closed properly • No recording paper • Paper jammed in the recording section 	<ul style="list-style-type: none"> • Remove the document • Push cover closed until you hear a click • Load new paper roll • Remove the jammed paper 	III-5-1 VI-5
Recording paper is jammed	<ul style="list-style-type: none"> • Recording paper is set incorrectly • Paper jammed in the recording section 	<ul style="list-style-type: none"> • Reload paper roll correctly • Remove the jammed paper 	III-5-1 VI-5
Received copies are blank	<ul style="list-style-type: none"> • Recording paper roll has been inserted upside down • Documents were not sent correctly 	<ul style="list-style-type: none"> • Reload the paper roll correctly • Contact the sender 	III-5-1
Telephone rings continuously	<ul style="list-style-type: none"> • No recording paper • Auto Answer is OFF • Cover not closed properly • Paper jammed in the recording section 	<ul style="list-style-type: none"> • Load new paper roll • Turn Auto Answer to ON • Push cover closed until you hear a click • Remove the jammed paper 	III-5-1 IV-1-7 VI-5
Image quality is not good	<ul style="list-style-type: none"> • Wrong type of recording paper is used • Printing head is dirty • Sender's resolution or contrast setting may need adjustment 	<ul style="list-style-type: none"> • Replace with Brother thermal printing paper • Clean the printing head • Contact the sender 	VII-2
Polling reception does not work	<ul style="list-style-type: none"> • Sender has not set up to perform polling • Polling security codes do not match • Sender is not using a Brother series machine 	<ul style="list-style-type: none"> • Contact the sender to be sure he has set up for polling • Contact the sender to confirm the code being used • Contact the sender to confirm the machine being used 	

SENDING

SENDING

SYMPTOM	POSSIBLE CAUSE	ACTION	cf.
Document jam	<ul style="list-style-type: none"> • Jam in the scanning section 	<ul style="list-style-type: none"> • Open the panel cover and remove the jammed paper. Close the cover (and listen for the click). 	
Document not feeding properly	<ul style="list-style-type: none"> • Cover not closed securely • Document is too thick or thin, too small, wet, wrinkled, curled or torn • Document guide not adjusted to document size • More than 20 pages of documents in the feeder 	<ul style="list-style-type: none"> • Push the panel cover closed until you hear a click • Use a photocopier to make a copy, then send the copy • Adjust the document guide to fit the document size • Set only 20 pages of the document in the feeder at one time 	
Documents are impossible to feed	<ul style="list-style-type: none"> • Documents have been inserted in the position for recording paper output 	<ul style="list-style-type: none"> • Insert the documents into the transmission document wire extension 	III-8-1
Password transmission error	<ul style="list-style-type: none"> • Password function on receiving end is OFF • Passwords do not match • Receiving unit has no password function • Receiving unit is not a Brother series machine 	<ul style="list-style-type: none"> • Contact the receiver • Contact the receiver to confirm the code being used • Contact the receiver • Contact the receiver to confirm the machine being used 	
Image quality of document is poor	<ul style="list-style-type: none"> • Problem with receiving unit • Scanning head is dirty • Scanning head is bad 	<ul style="list-style-type: none"> • Use your fax unit to make a test copy (If this is passable, the problem is at the other end.) • Clean the scanning head • Call your Brother service center 	III-8-1 VII-3
Documents sent are received blank	<ul style="list-style-type: none"> • Document is face up in the feeder 	<ul style="list-style-type: none"> • Set the document face down in the feeder and send it again 	
Auto transmission is not working	<ul style="list-style-type: none"> • The wrong (a non-fax) number was dialed • Polled, or transmission or redialing with a document in the feeder is being carried out 	<ul style="list-style-type: none"> • Double check the fax number you have registered in the machine • Use the interrupt function 	V-15-1
Delayed sending does not work	<ul style="list-style-type: none"> • The HOOK key has been pressed or the handset was picked up • Polled, transmission, or redialing with a document in the feeder is being carried out • The maximum number (three) of delayed transmissions have been set up (on the FAX-500M) 	<ul style="list-style-type: none"> • Refer to the instructions and begin again • Use the interrupt function • Wait until the delayed transmissions already set have been carried out 	V-15-1

TELEPHONE

SYMPTOM	POSSIBLE CAUSE	ACTION	cf.
One-touch and speed dialing don't work	<ul style="list-style-type: none"> • Power cord is disconnected • Numbers have been registered incorrectly • Your telephone has been set to the wrong PULSE/TONE setting • Numbers have been registered as group dial (on the FAX-500M) or chain dial keys 	<ul style="list-style-type: none"> • Plug the cord into the power outlet • Check and (if necessary) correct the registration • Check and (if necessary) correct the PULSE/TONE setting • Check and (if necessary) correct the registration 	III-6-1
No sound is produced when you press HOOK	<ul style="list-style-type: none"> • The power cord is disconnected • The monitor switch is set low • The telephone line is not connected 	<ul style="list-style-type: none"> • Plug the cord into the power outlet • Turn the monitor switch high. • Connect the fax unit to the telephone line 	III-6-1 II-3-4 III-7-1

COPYING

SYMPTOM	POSSIBLE CAUSE	ACTION	cf.
Nothing comes out of the slot	<ul style="list-style-type: none"> • The paper roll is not inserted properly • Recording paper jam • Cover not closed properly 	<ul style="list-style-type: none"> • Reload the paper correctly • Open the recording cover and remove the jammed paper. Make sure the paper is loaded correctly • Push the cover closed until you hear a click 	III-5-1 VI-5
No image appears on the paper	<ul style="list-style-type: none"> • The paper roll is loaded upside down • The document is upside down in the feeder 	<ul style="list-style-type: none"> • Reload the paper correctly and make another copy • Load the document in the feeder face down and make another copy 	III-5-1
Print quality of the copy is poor	<ul style="list-style-type: none"> • The wrong recording paper is being used 	<ul style="list-style-type: none"> • Use Brother thermal recording paper 	

OTHERS

OTHERS

SYMPTOM	POSSIBLE CAUSE	ACTION	cf.
Cover cannot be closed properly	<ul style="list-style-type: none">• Release levers have fallen into lower position	<ul style="list-style-type: none">• Pull up both release levers and close the cover again	VI-6

ERROR MESSAGES

An error message is displayed on the LCD when a malfunction occurs or when an operation has been done incorrectly. When some of the error messages described below appear on the screen, an alarm will sound continuously for 4 seconds.

<MACHINE ERRORS>

CHECK RECORDING PAPER

If the unit detects the end of the roll of the recording paper, this display will appear to inform you that the unit is out of paper. This message may also appear if the paper has not been loaded properly.

DOCUMENT JAM
PRESS STOP KEY

This indicates a document paper jam inside the machine or the feeder. Open the panel cover to remove the jammed document. When the jam has been corrected, close the cover. If this does not correct the error, contact your Brother service center and inform them of the situation.

RECORDING PAPER JAM

This indicates a recording paper jam inside the machine. Open the recording cover to pull the jammed paper out of the recording paper guide, as shown in the illustration below. When the jam has been corrected, cut the edge of the recording paper with a pair of scissors, and reset it properly in the guide. Then close the cover of the machine.

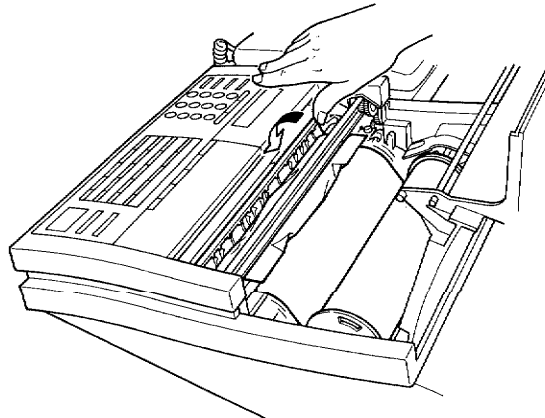

ERROR MESSAGES

CUTTER JAM

This indicates that the cutter is not at the home position because a recording paper jam is obstructing the movement of the cutter inside the machine. First, unplug the machine. Then open the cover to remove the jammed paper. (Use caution when handling the paper, as the cutter is quite sharp.) After the paper jam has been corrected, reset the paper roll in position, and close the cover. Finally, plug in the machine again. The cutter will return to the home position automatically.

PRINTER ERROR PRESS STOP KEY

This may indicate overheating due to a problem with the printing head. Let the unit cool down for one hour or more. If this does not correct the error, contact your Brother service center and inform them of the situation.

RECORDING COVER OPEN

The cover has not been closed properly. Check the position of the release levers on both sides inside the unit, and return them to the upper position, as shown in the illustration below. Then close the cover.

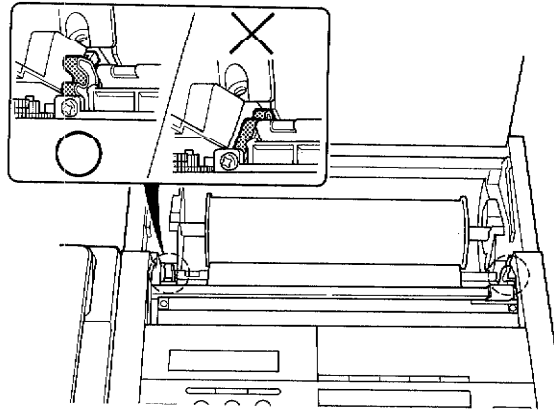

RECEIVING INTERFERENCE

This may indicate some error related to the recording paper, a lack of receiving memory (only for FAX-500M) at manual reception. Hang up the handset when manual reception. Information about correcting the situation will then appear on the LCD. This error message may also appear during polling or retrieval (only for FAX-500M) from a confidential mailbox.

PRINTING INTERFERENCE

This may indicate an error related to the recording paper. Press the STOP key or remove the document, and information about the situation will appear on the LCD.

MACHINE ERROR XX PRESS STOP KEY

This may indicate overheating due to overuse. Let the unit cool down for one hour or more. If this does not correct the error, contact your Brother service center and inform them of the situation.

If the error message on the LCD reads "MACHINE ERROR EA", this may indicate that document was removed from the feeder while transmission was still taking place.

<COMMUNICATION ERRORS>

NO RESPONSE OR BUSY

When you are making a transmission, this message indicates that either the other party is busy or that no response has been received. If you have turned the Auto Redial function ON (see page IV-1-10), the machine will automatically try the number again after a few minutes. If you have selected to turn the Auto Redial function OFF, this transmission will be unsuccessful and transmission verification report (busy) will be printed out.

NO CONNECTABILITY

When you are the receiving party, this message will indicate that certain functions—password on the FAX-410/500M, and the confidential mailbox and relay broadcasting on the FAX-500M—cannot be enabled because the sending party's machine is not a Brother machine.

ID MISMATCH

This may indicate that the incorrect ID number (for password, password plus, and secure polling on the FAX-410/500M, and the confidential mailbox, confidential mailbox retrieval, or relay broadcast request on the FAX-500M) was used when the sender made his transmission. Contact the sender to verify that your ID codes match up correctly. A transmission verification report (error) will be printed out.

This may also occur if you have entered the wrong ID code when attempting to print out a confidential message from the memory on a FAX-500M. Double check the ID and try the operation again.

LINE DISCONNECTED

This message may indicate that either the sending or the receiving party has interrupted the fax transmission (or reception) operation. If you are the sender, this may also indicate a missed telephone line connection due to an ID mismatch or the receiving party being unprepared for polling, and so on. In such circumstances, check with the receiving party to learn what is happening at the other end of the line.

COMM ERROR XX YY

This message indicates that some communication error has taken place. "XX YY" represents the error codes used to provide more detailed information about the error. Refer to the list shown below.

ERROR MESSAGES

Error Codes

- 40 06 — This indicates that a unit which has not been set up for polling has been polled by another unit.
- 40 11 — This indicates that the unit has attempted relay broadcasting, but for an unregistered group number (FAX-500M only).
- 40 13 — This indicates that the machine has been set up for secure polling, but the polling request has come from a unit which is not a Brother machine.
- A0 01 — This indicates poor telephone line conditions.
- If any error code other than those listed here appears on the LCD, contact your Brother service center and inform them of the situation.

<OTHER ERRORS – BOTH MODELS>

NOT REGISTERED

This message indicates that you have attempted to reach a one-touch or speed dialing number that has not yet been registered. (See page IV-4-1 and IV-5-1.)

INVALID OPERATION
NO NUMBER REGISTERED

This message indicates that no one-touch or speed dialing numbers have been registered when the TEL-INDEX key is pressed or the TEL-INDEX list has been called up.

NOT REGISTERED
STATION ID

This indicates that you have attempted to use the super COVERPAGE function before registering your station ID. Register the station ID (see page IV-1-2) first, and then try the operation again.

NO DOCUMENT IN FEEDER
SET DOCUMENT(S)

This indicates that no document(s) has been set into the document feeder, when you have tried to select contrast change or multiple resolution setting, or confidential transmission on FAX-500M

<OTHER ERRORS – FAX-500M ONLY>

INVALID OPERATION
CHECK YOUR NUMBER

This indicates that you have pressed a Group key (a one-touch number registered as a group key) before pressing the BROADCAST key.

- OR -

MEMORY FULL
PRESS STOP TO AVOID

No more data can be stored in the memory. Press the STOP key to erase the entire memory, or press the START key to send the stored data out of the memory.

It is also possible to create more space in the unit's memory by printing out some confidential documents or documents that have been received into memory. In addition, more space can be made available by sending documents that

have been stored into memory. A Memory Used Report (see page V-9-2) will inform you as to how much memory in the machine is available.

MEMORY FULL
PRESS STOP KEY

This message indicates that the memory is full, and cannot accept any more data. Press the STOP key to cancel your current transmission.

MEMORY FULL

This indicates that you cannot do broadcast transmission because of memory full.

TOO MANY STATIONS FOR
BROADCAST REQUEST(S)

This indicates that you have attempted broadcasting to more than the total maximum number of stations (139).

GROUP 01
THE NUMBER REGISTERED

This indicates that the group number you selected has already been used.

ALL GROUP KEYS IN USE
NO MORE NO.CAN BE REGIST

This indicates that all group numbers have already been registered.

VII. Cleaning

To ensure a long and useful life for your machine, regular cleaning is essential. For best results clean the scanning and printing areas of your machine every time you use up a roll of recording paper. The following points should be borne in mind.

- 1) **To avoid the risk of an electric shock, unplug the machine before cleaning.**
- 2) **Do not use water or organic solvents of any kind (thinners, for example) to clean the machine.**
- 3) Use a slightly damp cloth to wipe any dirt off the surface of the machine.

To clean the working parts of the machine follow the steps described below.

CLEANING THE PRINTING AREA

CLEANING THE PRINTING AREA

First, unplug the machine. Open the unit, and remove the roll of recording paper from inside the machine.

When cleaning the printing head, use the slip of paper provided with the machine. Wet one end of the paper slip with isopropyl alcohol, and insert it under the guide until it will enter no further. Then continue across the unit as shown in the illustration, inserting the paper so the entire head is cleaned with the alcohol. (Either side and both ends of the paper slip can be used for cleaning the printing area.)

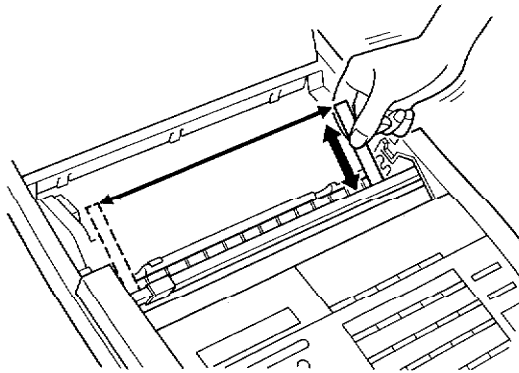

CLEANING THE SCANNER

Lift up on the front cover of the unit to open the machine.

Carefully remove any dirt from the clear glass cover of the scanner using a soft cloth soaked in alcohol. Do not use organic solvents such as thinners, or petrol.

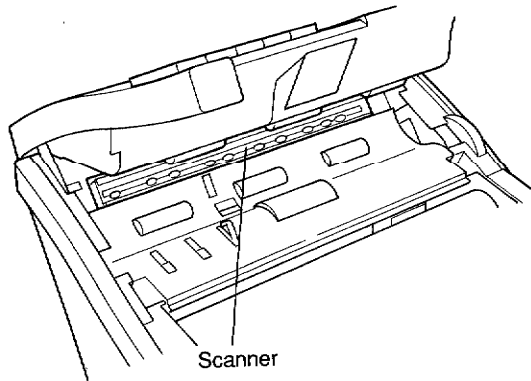
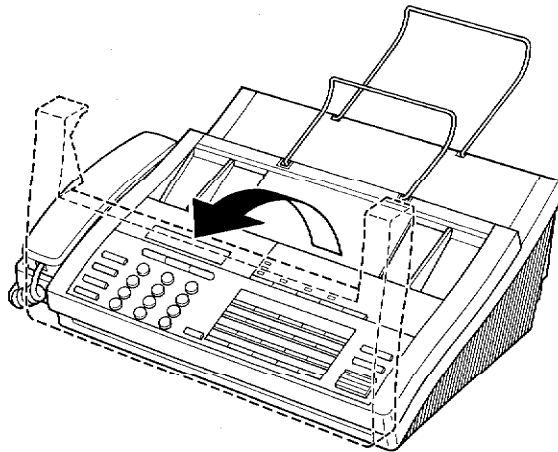

VIII. Specifications

Type	Desktop facsimile transceiver
Compatibility	CCITT Group 3
Coding system	Modified Huffman (MH) and Modified Read (MR) on the FAX-410/500M Modified Modified Read (MMR) on the FAX-500M
Modulation	CCITT V.27 ter and a V.29 modem (9600bps)
Document input size	8.5"/216mm x 5.8"/148mm
Scanning/Printing width	8.2"/208mm
Paper roll size	8.5" x 164"/216mm x 50m
Scanner type	Contact Image Sensor (CIS)
Printer type	Line Thermal
Gray scale	16
Paper Cutter	Automatic
LCD	24 digits x 2 lines
Polling types	Standard/Security/Turnaround Sequential (FAX-500M only)
Broadcasting (only for FAX-500M)	Sequential/Relay
Contrast control	Auto/Super Light
Resolution	<ul style="list-style-type: none">• Standard (203 x 98 lines/inch)• Fine (203 x 196 lines/inch)• Super Fine (203 x 392 lines/inch)• Photo (203 x 196 lines/inch)
One-touch dial	40 stations (FAX-500M) 20 stations (FAX-410)
Speed dial	100 stations (FAX-500M) 40 stations (FAX-410)
Total station memories	140 (FAX-500M) 60 (FAX-410)
Memory (only for FAX-500M)	256KB, expandable 512KB or 768KB.
Automatic redial	3 times (5 minute intervals)
Speaker type	Monitor
Auto answer (# of rings)	Shorter(1 ring)/Longer(4 rings)
Communications source	Public switched telephone network (or compatible approved PBX)
Operating environment	41 - 95°F
Power source	120 VAC, 60Hz
Power consumption	Stand-by: under 15 watts Peak:under 150 watts
Dimensions	16.0" x 15.0" x 5.7"/407 mm x 380 mm x 145 mm
Weight	14.3lbs/6.5 kg

Specifications are subject to change for improvement without prior notice.



brother®